



KENTUCKY CORRECTIONAL INDUSTRIES

60th Anniversary Edition

1954-2024

*PRODUCT
AND SERVICES GUIDE*

STATE CONTRACT # 758-1900000370

TEAM 
KENTUCKY®

**JUSTICE AND
PUBLIC SAFETY CABINET**

Commonwealth of Kentucky
KCI Sales Representatives
Kentucky Correctional Industries
1041 Leestown Road
Frankfort, KY 40601

Office: 502-573-1040

KCI.ky.gov

Toney Bailey
Director
Mobile: 502.229.4984

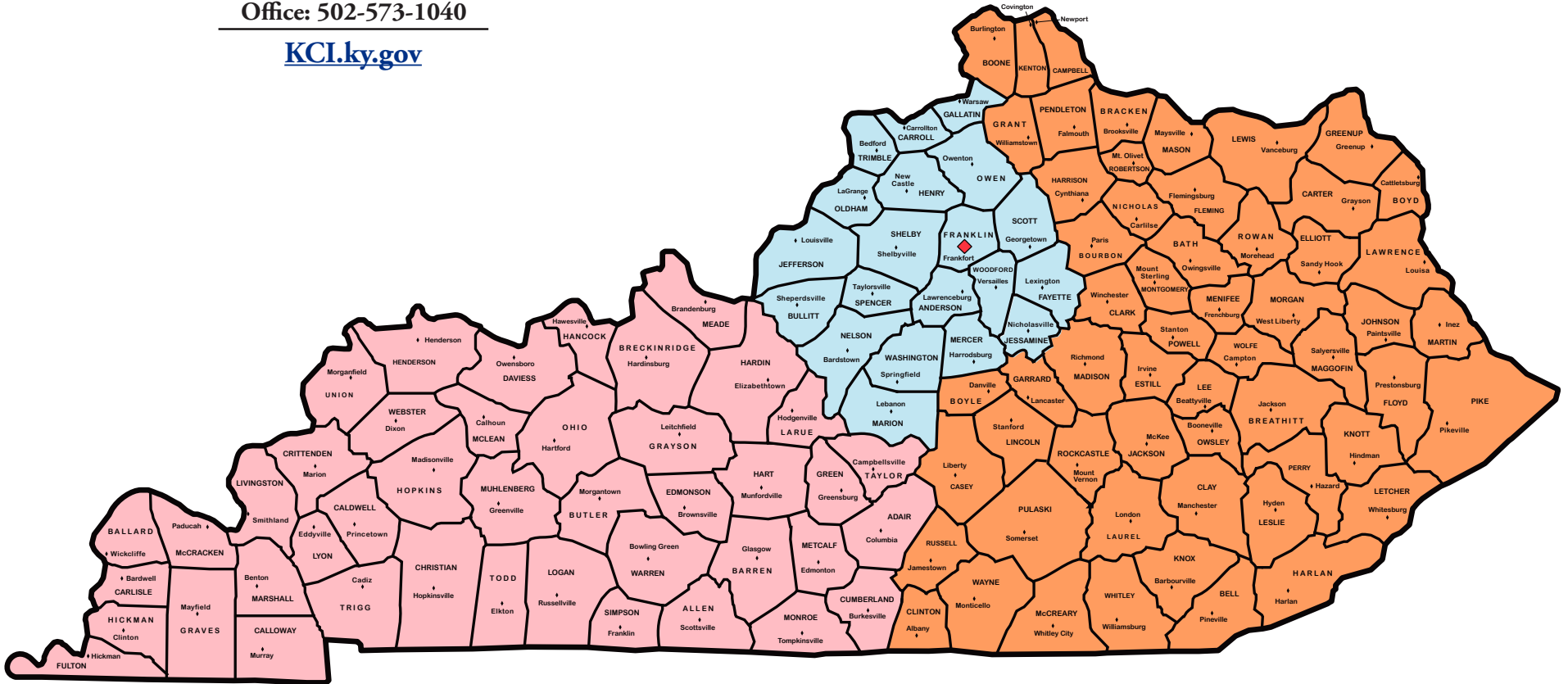





-  **KCI Showroom Frankfort - 502.782.9573**
-  West Region Representative - 502.330.9012
-  Central Region Representative - 502.330.5983
-  East Region Representative - 502.382.7504

Table of Contents

KCI SALES REPRESENTATIVE MAP	i
WHAT KCI IS ALL ABOUT	1
<i>KCI POLICIES</i>	2
<i>SERVICES</i>	4
RENTAL SPACE	7
OFFICE FURNITURE	9
<i>SIGNATURE SERIES</i>	10
<i>PENNYRILE SERIES</i>	13
<i>LEGACY SERIES</i>	17
<i>TRADITIONAL SEATING</i>	24
<i>LOUNGE AND RECEPTION</i>	26
TABLES	45
<i>PORTICO TABLES (Fixed Leg)</i>	46
<i>ULTRALITE FURNITURE (Folding Leg)</i>	48
CORRECTIONAL FURNITURE	49
METAL PRODUCTS	53
<i>LOCKERS</i>	54
<i>LOCKER ACCESSORIES</i>	57
<i>LOCKER INFORMATION</i>	58
<i>METAL CABINETS & WARDROBES</i>	59
<i>OPEN STEEL SHELVING UNITS</i>	61
<i>CLOSED STEEL SHELVING UNITS</i>	62
<i>INDIVIDUAL SHELVING & ACCESSORIES</i>	63
<i>GENERAL INFORMATION SHELVING</i>	64
TEXTILES, MATTRESSES & PILLOWS	67
<i>TEXTILES</i>	68
Uniforms & Scrubs.....	68
Uniforms & Scrubs.....	69
Transport Scrubs.....	70
T-shirts, Boxers, Socks & Belts	71
Bath & Bed.....	72
<i>MATTRESSES & PILLOWS</i>	73

Table of Contents

<i>SHOWER CURTAINS</i>	74
JANITORIAL SUPPLIES & CLEANING PRODUCTS	75
<i>JANITORIAL</i>	76
<i>DETERGENTS</i>	78
<i>FLOOR CARE</i>	80
<i>CLEANERS</i>	81
<i>MISCELLANEOUS</i>	82
PRINT SERVICES	85
<i>OFFSET AND DIGITAL PRESSES</i>	86
Business Cards, Letterhead & Envelopes	86
Forms, Certificates & Hang Tags	87
Magazines, Booklets, Bookmarks, Calendars & Planners	88
Posters & Signs	89
Mail Merge, Sequential Numbering, Newsletters, Advertisements & Brochures	90
<i>TRANSFER PRINTING</i>	91
Pendants, Ornaments, Mug, Tumblers and Textiles	91
<i>EMBROIDERY</i>	92
<i>FABRIC PRINTING</i>	93
<i>STICKERS & LABELS</i>	94
CUSTOM PRODUCTS	95
<i>METAL PRODUCTS</i>	96
<i>REUPHOLSTERY</i>	97
<i>WOOD FURNITURE</i>	98
Athletic Lockers with Customized School Logo	98
Kitchen Island, Board Room, Conference Room & Treatment Table	99
Mail or License Plant Cabinet, Magazine Rack, Bookcase, Reception Area	100
Tables, Benches & Chairs	101
Podiums, Coat Trees & Business Card Holder	102
<i>HANDMADE ITEMS</i>	103
Handmade Seals	103
Airbrushing, Nameplates & Billy Bats	104
PERSONAL PROTECTIVE EQUIPMENT (PPE)	105
<i>OFFICE DESK BARRIER</i>	106
<i>PPE SURGICAL MASKS</i>	107
<i>PPE MEDICAL POUCHES</i>	108
PRISON INDUSTRY ENHANCEMENT CERTIFICATION PROGRAM (PIEPC)	109



KENTUCKY CORRECTIONAL INDUSTRIES

WHAT KCI IS ALL ABOUT

KCI's Mission Statement

To provide inmates with a realistic work experience and teach marketable job skills. This is part of an effort to improve their chances of securing gainful employment upon release from custody, reduce the state's recidivism rate and lower the Commonwealth's resource commitment for maintaining the prison system.

Kentucky Correctional Industries (KCI) was founded in 1954 with a mandate to provide training and employment to state inmates. Today, KCI employs over 400 - 700 state inmates. By giving inmates the opportunity to learn marketable skills and develop good work habits, KCI has contributed to the reduction of recidivism, improved prison safety, and lowered the cost of incarceration throughout the state prison system.

KCI receives no appropriated tax monies and generates all operating funds and expansion capital from industry profits. KCI incurs the normal operating expenses any private company would incur such as utilities, salaries and equipment.

The success of KCI is not only measured in dollars, but in the reduction of the recidivism rate for those inmates trained in our programs. An independent study done by Eastern Kentucky University, College of Criminal Justice, found only 13.5% of inmates who had worked in KCI industries returned to prison, compared to 42% returning from the general population.

KCI is now structured into 16 separate industries each headed by an Operations Manager able to quickly make the appropriate business decisions necessary to meet your evolving procurement needs. In these times of heightened budgetary constraints, we recognize the importance of making wise purchases of products and services. That is why we have formed several important partnerships with nationally recognized suppliers, who work with prison industries throughout the United States. We think you will agree they have enabled us to offer a great selection of competitively priced products and services.

This catalog is a comprehensive overview of Kentucky Correctional Industries. You will find useful information on ordering, pricing and payment options. **When you are ready to place an order contact the sales person covering your geographical location (see map inside front cover) or visit our web site: kci.ky.gov.**

"The success of KCI is not only measured in dollars, but also in reduction of the recidivism rate for those inmates trained in our programs."

***- Toney Bailey
Director, Kentucky Correctional Industries***



Kentucky Correctional Industries
1041 Leestown Road
Frankfort, KY 40601

KCI POLICIES

Disclaimer

Due to the uniqueness of working with inmate labor within an institutional environment, deadlines or production may be compromised or altered. KCI will make every effort to communicate this to our customers should those instances arise.

Delivery

Due to departmental policies and regulations, KCI is prohibited from delivering to private residences.

Catalog pricing reflects customer pick-up at the Frankfort warehouse loading dock only.

Catalog pricing for items produced at the Garment Plant and the Soap Plant include shipping by a third party entity.

Items delivered by one of KCI's fleet of trucks will have a delivery charge added to the customer invoice. This is based on the number of miles from KCI's Frankfort warehouse to the customer's destination, number of trips and trucks needed for delivery.

Inside delivery and/or set-up is available upon customer request.

- Inside Franklin County \$75.00
- Up to 49 miles outside Franklin County \$125.00
- 50 - 99 miles outside Franklin County \$175.00
- 100 - 149 miles outside Franklin County \$240.00
- 150 - 199 miles outside Franklin County \$300.00
- 200+ miles outside Franklin County \$405.00
- Set in place charge is \$150.00 per hour.

Charges will be added to the customer's invoice.

Please provide the following information when requesting inside delivery and set-up of furniture orders:

- Floor location in the building
- Availability of freight elevator
- Size of elevator
- Are stairs the only access to floor location?
- Width of stairs
- Width of narrow hallways and doors
- Any unusual circumstances regarding the location

Providing this information prior to delivery will encourage efficient scheduling of equipment and personnel to ensure reasonable charges are added to your invoice. Occasional delivery delays may be experienced due to scheduling considerations on all inside delivery and set-up orders.

KCI trucks are scheduled to service areas in Kentucky on a timely basis. Delivery of the order will be made when the KCI truck is scheduled into the customer's area in Kentucky.

Your order may be picked up at the KCI warehouse with prior arrangement.

For Customer Pick-Up

KCI's Warehouse is located at:
1041 Leestown Road
Frankfort, KY 40601
(502) 592-2805

Warehouse Hours are:
Monday - Friday
8 a.m. - 3 p.m.*

*Eastern Standard Time

Other Fees

Cancellations or returns will be subject to a 30% restocking fee.

Custom made items are non-refundable.

Customer Service Department

All KCI products are supported by the KCI Service Department to handle repairs and replacement parts. Please refer to the Limited Warranty and Service Policy for information.

To schedule a service call, contact our Warehouse Supervisor at (502) 592-2805.

KCI POLICIES

Ordering

Orders should be signed by an authorized person and submitted to:

Kentucky Correctional Industries
1041 Leestown Road
Frankfort, Kentucky 40601

or

To the territory's sales representative

Please note the contact person and phone number on all Purchase Orders. Billing and shipping address must be shown on the order. To avoid misunderstandings, the catalog number, as well as the item description must be used. Where color or finish is listed, please designate preference on the order. Do not send check or remittance with the order. Telephone orders are accepted; however, these should be followed by a written order marked "CONFIRMING" to avoid duplication.

Receiving

When merchandise is received, if shipping damage or other defects are noted, please do not accept the merchandise. Please make a notation of the problem on both copies (yours and the driver's) of the delivery form. HAVE THE DRIVER SIGN BOTH COPIES. If a concealed shortage, overage, or damage is discovered later, notify KCI within 15 working days.

Warranty

KCI warrants 12 months (1 yr) with proof of purchase on all wood, metal & seating items to be free from defects in materials and/or workmanship. If any defect is discovered within the 1-year warranty period, KCI will repair or replace (at KCI discretion) the unit free of charge. All service requests must be in writing and directed to the attention of your Sales Representative.

These warranties do not apply to defects caused by abuse, misuse, neglect or alteration of the unit.

Service Calls

If after the 1-year warranty period your unit requires service, repair or replacement, a service call will need to be requested in writing to your Sales Representative.

Pricing

Every effort is made to maintain competitive pricing for all KCI products and services. Changes in material and operating cost will necessitate price adjustments on various items and, from time to time, items are discontinued or styles revised. If this occurs on any item on your order, you will be consulted before your order is processed.



Kentucky Correctional Industries
 1041 Leestown Road
 Frankfort, Kentucky 40601

SERVICES

PRINTING

Kentucky Correctional Industries' Printing Plant offers top quality printing at competitive prices. Fast and accurate cost quotations can be provided to you via phone, or e-mail. All jobs are guaranteed to the fullest satisfaction. Our professional staff will gladly offer tips on the most effective way to produce your printed product with the effect and impact you desire.

KCI's print shop provides a broad range of services for the Commonwealth. Our services include, but are not limited to: graphic design & layout, pre-press prep, bindery and finishing work including booklet making, metal and plastic binding, with an inventory of standard stocks and the capability of ordering specialty stock. Our shop is capable of printing sizes ranging from business cards to posters. We offer standard printing and specialize in carbonless forms. We can fill your needs for parking permits, labels and decals.

Our designers can turn your hand written rough drawn ideas into eye-catching works of art. Contact the Operations Manager today for pricing and any additional questions.

We also have teams specializing in screen print design/printing and embroidery.

**KCI Printing Plant:
(502) 222-9058**

*KCI Specialty Services
can meet many of your additional needs.
We offer quality workmanship
at competitive prices.
KCI can take care of a number
of your business organizational needs.*



Digital Printing



Offset Printing

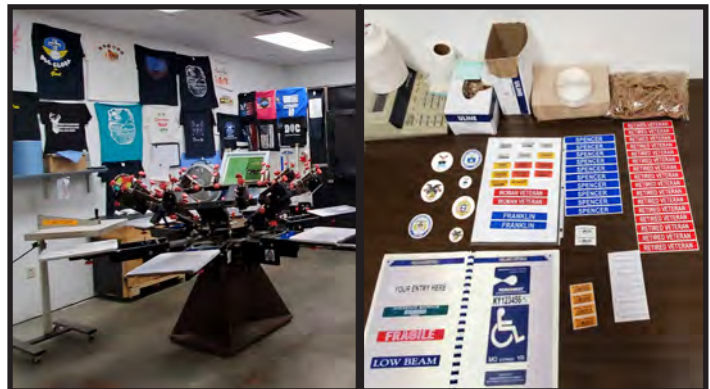

Screen Printing

Stickers



Embroidery

AND MORE!

SERVICES

BRAILLE TRANSCRIPTION

Since its beginning in 2000, KCI Braille Services has earned a reputation as a producer of quality Braille transcription and graphics, delivered in a timely manner. Inmates at Kentucky Correctional Institution for Women must complete a certification course given by the National Library of Congress and must submit a manuscript to be graded before receiving National Library Service certificate in literary braille. KCI Braille Services is fully equipped to create Braille as a finished product including literary proofreading, and large type covers/labels.

**KCI Braille Transcription:
502-241-8454 ext. 2248**



KCI MOVING CREW

No matter the size or the location, if you need it moved we can move it.

The KCI Moving Crew is one of the fastest growing services we offer.

Contact Brad Holt today to schedule your next move.

**KCI Moving Crew:
(502) 592-2805**

E-mail: Brad.Holt@ky.gov

KCI MOVING RATES

- Rates include travel time to and from the Frankfort warehouse.
- Regular Rate: \$200.00
(8:00 am through 3:30 pm, M-F).
- Overtime Rates: 1.5 x the hourly rate (before 8:00 am and after 3:30 pm M-F).
- There is a two hour minimum for all moves.
- There will be a \$500.00 cancellation fee for moves not canceled within 72 hours of its scheduled move date.



RENTAL SPACE

***Looking for a place for your Agency or Cabinet to have a meeting or event?
Look no further than KCI.***

KCI has (2) conference/training rooms and a large showroom available for your needs.
The rooms are available for use Monday through Friday from 8:00am to 4:00pm.

Large Conference/Training Room

Seats up to 30 people comfortably.

Has an electronic white board available for use.

This space is available for \$175.00 for a full day or \$100.00 for a half day.

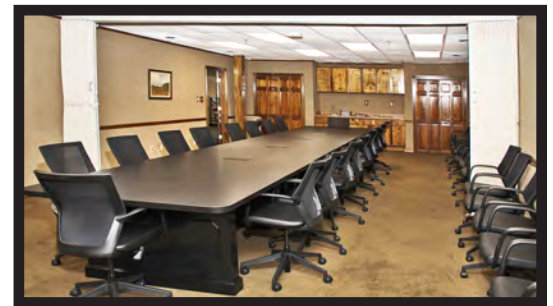
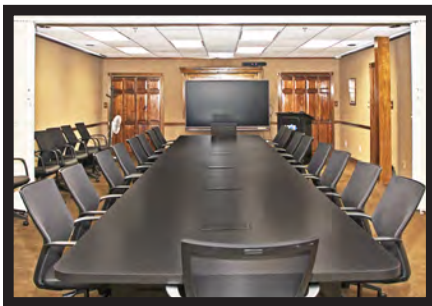

Small Meeting Room

Seats up to 15 people comfortably.

This space is available for \$75.00 for a full day or \$50.00 for a half day.

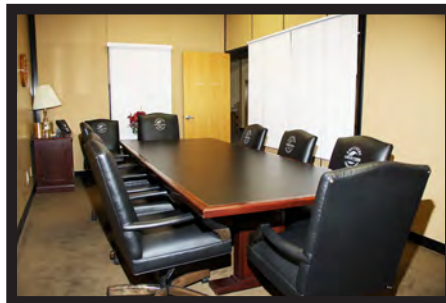

Showroom/Event Space

Seats up to 100 people comfortably.

This space is available for \$300.00 for a full day or \$200.00 for a half day.



Set Up/Clean Up Service

Need help with setting up and cleaning up from your meeting or event?
KCI can help with that.



KCI has an inmate staff available for assistance.
Ask for this assistance when scheduling your space.



Billing Made Easy



Payment for use of these spaces will be billed to your agency or cabinet by our Fiscal staff. To pay through emars simply provide your agency number and billing contact email address when scheduling your space and our Fiscal staff will email your invoice with emars payment document listed at the top.

Rather use your state ProCard? We can accommodate that too. Simply provide a billing contact name, phone number and email address and our Fiscal staff will reach out and obtain that information from you and supply you with a receipt after you have been charged.

**To schedule one of KCI's spaces for your meeting or event
please call (502) 782-9562.**

OFFICE FURNITURE

The manufacturing of hand-crafted wood furniture is a scarce and costly art these days. At KCI, we produce some of the most beautiful and affordable wood office furniture available anywhere. Select hardwoods milled from prime cut stock are transformed meticulously into the finished product.

KCI supports and purchases from vendors who practice sustainable foresting and use eco-friendly Sherwin-Williams® stains and finishes. The use of high quality Formica™ laminate, Belwith® decorative hardware, ball bearing drawer slides and a central locking system all contribute to a quality end product.

Pictured is the Signature Series, the premier style offered by KCI



• **PRICES SUBJECT TO CHANGE WITHOUT NOTICE** •

SIGNATURE SERIES



Features

- Sierra, Cherry and Walnut finish
- Heavy duty drawer pulls
- Hardwood and veneer
- Premier keyboard support, mouse pad *(optional)*
- Full-extension ball bearing drawer slides

Pictured

- ① Office Credenza with Doors and Two Door Hutch
- ② Two Drawer Lateral File
- ③ Office Desk

SIGNATURE SERIES



EXECUTIVE DESK
48D x 78W x 30H
10-S-EDS / 10-S-EDC / 10-S-EDW
\$1,866

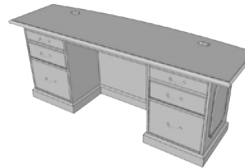

EXECUTIVE CRENZA
24D x 78W x 30H
10-S-ECS / 10-S-ECC / 10-S-ECW
\$1,442

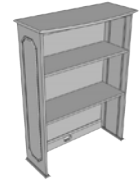

LATERAL FILE HUTCH
14.75D x 36W x 48H
10-S-LFHS / 10-S-LFHC / 10-S-LFWH
\$470

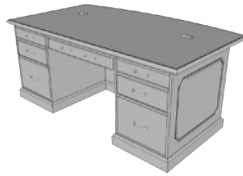

OFFICE DESK
42D x 72W x 30H
10-S-ODS / 10-S-ODC / 10-S-ODW
\$1,792

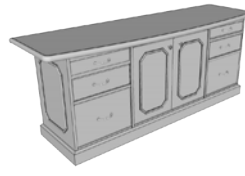

EXECUTIVE CRENZA WITH DOORS
24D x 78W x 30H
10-S-ECDS / 10-S-ECDC / 10-S-ECDW
\$1,599

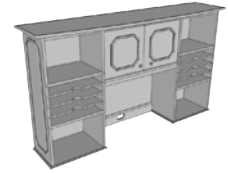

TWO DOOR HUTCH
17D x 72W x 41H
10-S-H2S / 10-S-H2C / 10-S-H2W
\$798

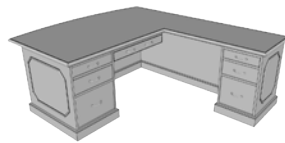

SINGLE PEDESTAL OFFICE DESK (LEFT / RIGHT RETURN)
42D x 72W x 30H (DESK)
24D x 45W x 30H (RETURN)
10-S-SPSD-LS / 10-S-SPSD-LC / 10-S-SPSD-LW LEFT RETURN
10-S-SPSD-RS / 10-S-SPSD-RC / 10-S-SPSD-RW RIGHT RETURN
\$2,295



LATERAL FILE CRENZA
24D x 78W x 30H
10-S-LFCS
10-S-LFCC
10-S-LFCW
\$1,761

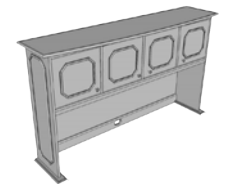

FOUR DOOR HUTCH
17D x 72W x 41H
10-S-H4S / 10-S-H4C / 10-S-H4W
\$734

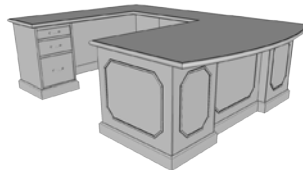

WRAP AROUND U STATION (LEFT / RIGHT RETURN)
72D x 102W x 30H
10-S-WAU-LS / 10-S-WAU-LC / 10-S-WAU-LW LEFT RETURN
10-S-WAU-RS / 10-S-WAU-RC / 10-S-WAU-RW RIGHT RETURN
\$2,826

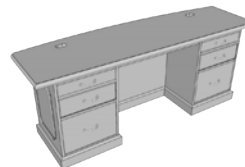

OFFICE CRENZA
24D x 72W x 30H
10-S-OCS / 10-S-OCC / 10-S-OCW
\$1,426



LATERAL FILE HUTCH WITH DOORS
49" x 36" x 17.25"
10-S-LFHDC
10-S-LFHDS
10-S-LFHDW
\$ 550



STAND ALONE RETURN (LEFT / RIGHT RETURN)
26.5D x 45W x 30H
10-S-RTN-SA-LS / 10-S-RTN-SA-LC / 10-S-RTN-SA-LW LEFT RETURN
10-S-RTN-SA-RS / 10-S-RTN-SA-RC / 10-S-RTN-SA-RW RIGHT RETURN
\$857

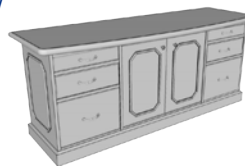

OFFICE CRENZA WITH DOORS
24D x 72W x 30H
10-S-OCDS / 10-S-OCDC / 10-S-OCDW
\$1,581

FEATURES

BULL NOSE BOWED EDGES

FULL-EXTENSION BALL BEARING DRAWER SLIDES

DOVETAIL DRAWER CONSTRUCTION

CENTRAL LOCKING SYSTEM ON ALL DESKS

ADJUSTABLE SHELVES UNLESS OTHERWISE NOTED

FINISHES



SIERRA



CHERRY

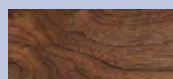

WALNUT

Office Furniture



2 DRAWER LATERAL FILE
23.5D x 38W x 30H
10-S-LF2S
10-S-LF2C
10-S-LF2W
\$982



3 DRAWER LATERAL FILE
23.5D x 38W x 42H
10-S-LF3S
10-S-LF3C
10-S-LF3W
\$1,265



CLOSED BOOKCASE
23.5D x 38W x 30H
10-S-BKCS
10-S-BKCC
10-S-BKCW
\$735



OPEN BOOKCASE
(Fixed Shelf)
23.5D x 38W x 30H
10-S-BKOS
10-S-BKOC
10-S-BKOW
\$634

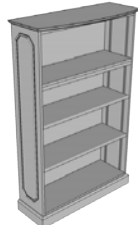

BOOKCASES
60 Inch Height
14.5D x 38W x 60H
10-S-BK60S
10-S-BK60C
10-S-BK60W
\$603

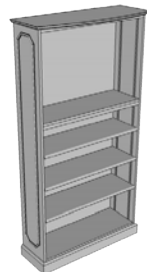

73 Inch Height
15.75D x 38W x 73H
10-S-BK73S
10-S-BK73C
10-S-BK73W
\$684



12 SIDED TABLE
42D x 30H
10-S-12STS
10-S-12STC
10-S-12STW
\$926

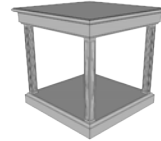

OCCASIONAL TABLE
25.5D x 24W x 24H
10-S-OTS
10-S-OTC
10-S-OTW
\$277

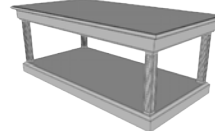

MAGAZINE TABLE
26.5D x 45W x 18H
10-S-MTS
10-S-MTC
10-S-MTW
\$408

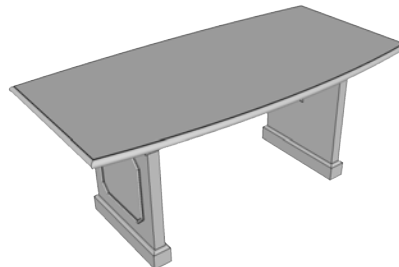

CONFERENCE TABLES
72 Inch Width, 36 Inch Depth
36D x 72W x 30H
10-S-CT 36/72S • 10-S-CT 36/72C • 10-S-CT 36/72W
\$899

72 Inch Width, 42 Inch Depth
42D x 72W x 30H
10-S-CT 42/72S • 10-S-CT 42/72C • 10-S-CT 42/72W
\$1,006

96 Inch Width, 42 Inch Depth
42D x 96W x 30H
10-S-CT 42/96S • 10-S-CT 42/96C • 10-S-CT 42/96W
\$1,208



REPLACEMENT KEYS
for wood suite furniture
10-Keys
\$6.00 for a set of two

NOTE:
Last letters of catalog number
indicate stain color and/or style

S = Sierra
C = Cherry
W = Walnut
L = Left
R = Right

**Keyboard
Tray**



Catalog #	Description	Price
10-KBDX	Deluxe keyboard tray	\$250

Comes fully loaded, with wrist pads and advanced ADA spring assist.

It also has a locking level for convenient positioning, and the mouse pad is felt covered and can be placed on the right or left.

PENNYRILE SERIES

The Pennyrile Series offers a traditional feeling of warmth and beauty with classical lines and quality appointments – practical and convenient for today's electronic office.

The series is designed for administrative and clerical settings. A wide range of pieces are available to meet just about any offices' needs. The Pennyrile Series offers exceptional value for the professional office desiring to project a classic and refined image which will not go out of style.

Its abundance of style and sophistication set it apart from run of the mill office furniture.



PENNYRILE SERIES

- Traditional luxury affordably priced
- Classic frame and panel design



Features

- Adjustable keyboard support and mouse pad.
(optional purchase)
- Full-extension ball bearing drawer slides.
- Wire management system.
- Laminate top is scratch, stain and mar-resistant.
- Heavy duty drawer pulls.
- Mahogany, Walnut and Black finish available.
- Adjustable shelves on bookcases.

Pictured

- ① Single Pedestal Desk with Return
- ② Wrap Around U Station
- ③ Reception Center *(Mahogany)*

Keyboard Tray



Catalog #	Description	Price
10-KBDX	Deluxe keyboard tray	\$250

Comes fully loaded, with wrist pads and advanced ADA spring assist.

It also has a locking level for convenient positioning, and the mouse pad is felt covered and can be placed on the right or left.

PENNYRILE SERIES

Office Furniture

DESKS



STANDARD DESK
30D x 72W x 30
10-P-SDM
10-P-SDW
10-P-SDBLK
\$1,281

STANDARD DESK
30D x 66W x 30
H10-P-SD66M
10-P-SD66W
10-P-SD66BLK
\$1,264

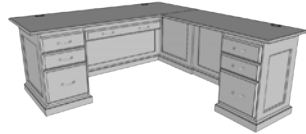

**SINGLE PEDESTAL
(LEFT / RIGHT RETURN)**
30D x 72W x 30H (DESK)
22D x 50W x 30H (RETURN)

10-P-SPSD-LM
10-P-SPSD-LW
10-P-SPSD-BLK

10-P-SPSD-RM
10-P-SPSD-RW
10-P-SPSD-BLK
\$1,577

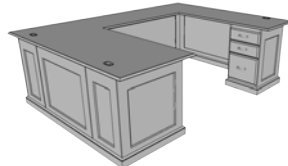

**WRAP AROUND U STATION
(LEFT / RIGHT RETURN)**
72D x 96W x 30H

10-P-WAU-LM
10-P-WAU-LW
10-P-WAU-L-BLK

10-P-WAU-RM
10-P-WAU-RW
10-P-WAU-R-BLK
\$2052



STAND UP WORKSTATION
30D x 60W x 42H
10-P-SUWS-W
10-P-SUWS-M
10-P-SUWS-BLK
\$787

CREDENZAS

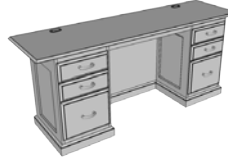

OFFICE CREDENZA
21D x 72W x 30H
10-P-OCM
10-P-OCW
10-P-OC-BLK
\$1,027

OFFICE CREDENZA
21D x 66W x 30H
10-P-OC66M
10-P-OC66W
10-P-OC66-BLK
\$1,013



**OFFICE CREDENZA
WITH DOORS**
21D x 72W x 30H
10-P-OCDM
10-P-OCDW
10-P-OCDBLK
\$1142



LATERAL FILE CREDENZA
21D x 76W x 30H
10-P-LFCM
10-P-LFCW
10-P-LFC-BLK
\$1,440



**STANDALONE RETURN
(LEFT / RIGHT)**
21D x 53W x 30H
10-P-RTN-SA-LM
10-P-RTN-SA-LW
10-P-RTN-SA-L-BLK
10-P-RTN-SA-RM
10-P-RTN-SA-RW
10-P-RTN-SA-R-BLK
\$644

HUTCHES



LATERAL FILE HUTCH
13D x 36W x 45H
10-P-LFHM
10-P-LFHW
10-P-LFH-BLK
\$376



LATERAL FILE HUTCH W/ DOORS
15D x 36W x 49H
10-P-LFHDM
10-P-LFHWD
10-P-H2-LFHDBLK
\$453

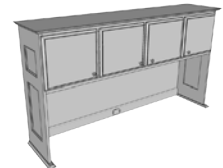

FOUR DOOR HUTCH
15.75D x 69W x 38H
10-P-H4M
10-P-H4W
10-P-H4-BLK
\$646



TWO DOOR HUTCH
15.75D x 69W x 38H
10-P-H2M
10-P-H2W
10-P-H2-BLK
\$659

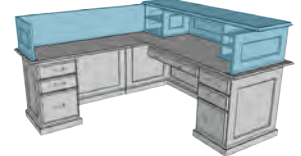

**RECEPTION CENTER TOP
(LEFT / RIGHT RETURN)**
**Left return shown attached above
on single pedestal desk*
78D x 70W x 14H
10-P-RC-LM
10-P-RC-LW
10-P-RC-L-BLK
10-P-RC-RM
10-P-RC-RW
10-P-RC-R-BLK
\$460

FEATURES

FRONT PULLS AVAILABLE IN
OIL RUBBED BRONZE OR
BRUSHED NICKEL

FULL-EXTENSION BALL BEARING
DRAWER SLIDES

DOVETAIL DRAWER
CONSTRUCTION

CENTRAL LOCKING SYSTEM
ON ALL LOCKING UNITS

WOOD FRAME AND PANEL
CONSTRUCTION

ADJUSTABLE SHELVES
UNLESS OTHERWISE NOTED

FINISHES



MAHOGANY



WALNUT

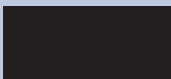

BLACK

Office Furniture

LATERAL FILES



2 DRAWER LATERAL FILE
21D x 40W x 30H
10-P-LF2M
10-P-LF2W
10-P-LF2-BLK
\$774



3 DRAWER LATERAL FILE
21D x 40W x 42H
10-P-LF3M
10-P-LF3W
10-P-LF3-BLK
\$996

BUFFET

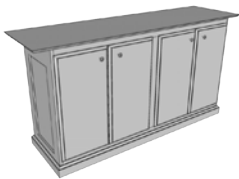

FOUR DOOR BUFFET
21D x 72W x 36H
10-P-4DBM
10-P-4DBW
10-P-4DBBLK
\$1,157

FOUR DOOR BUFFET
21D x 66W x 36H
10-P-4DB66M
10-P-4DB66W
10-P-4DB66-BLK
\$1,142

NOTE:
Last letters of catalog number indicate stain color and/or style

M = Mahogany
W = Walnut
BLK = Black
L = Left
R = Right

BOOKCASES



CLOSED BOOKCASE
21D x 40W x 30H
10-P-BKCM
10-P-BKCW
10-P-BKC-BLK
\$567



OPEN BOOKCASE
21D x 40W x 30H
10-P-BKOM
10-P-BKOW
10-P-BKO-BLK
\$490



49 Inch Height
13D x 38W x 49H
10-P-BK49M
10-P-BK49W
10-P-BK49-BLK
\$415

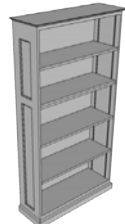

73 Inch Height
13D x 38W x 73H
10-P-BK73M
10-P-BK73W
10-P-BK73-BLK
\$536

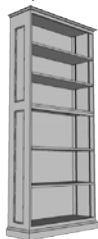

84 Inch Height
13D x 38W x 84H
10-P-BK84M
10-P-BK84W
10-P-BK84-BLK
\$582

TABLES



12 SIDED TABLE
43D x 30H
10-P-12STM
10-P-12STW
10-P-12ST-BLK
\$758

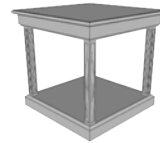

OCCASIONAL TABLE
20D x 23W x 24H
10-P-OTM
10-P-OTW
10-P-OT-BLK
\$242

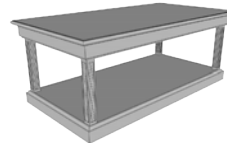

MAGAZINE TABLE
22D x 40W x 18H
10-P-MTM
10-P-MTW
10-P-MT-BLK
\$345



CONFERENCE TABLES
36D x 72W x 30H
10-P-CT36/72M
10-P-CT36/72W
10-P-CT36/72-BLK
\$705

36D x 96W x 30H
10-P-CT36/96M
10-P-CT36/96W
10-P-CT36/96-BLK
\$873

42D x 72W x 30H
10-P-CT42/72M
10-P-CT42/72W
10-P-CT42/72-BLK
\$790

42D x 96W x 30H
10-P-CT42/96M
10-P-CT42/96W
10-P-CT42/96-BLK
\$965

DETAILS

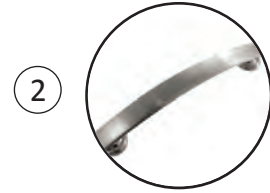
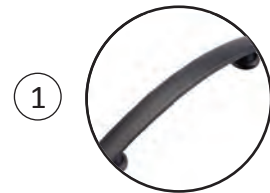

1 OIL RUBBED BRONZE
(STANDARD ON WALNUT & MAHOGANY FINISH)

2 BRUSHED NICKEL
(STANDARD ON BLACK FINISH)

REPLACEMENT KEYS
for wood suite furniture
10-Keys
\$6.00 for a set of two

LEGACY SERIES

The Legacy Series was developed as a vintage style with a modern flair to achieve a modern, contemporary look. Rounded edges and no surface overhangs clean up its lines and affords it a smaller footprint to fit into those tighter spaces.

Key quality details remain the same as KCI's other furniture series: Dovetailed drawers, full-extension ball bearing slides, and black laminate tops are standard features that all add a touch of grace.



LEGACY SERIES

"...our most affordable line of wood furniture"



Legacy Series Black Finish



Legacy Series Antique White

Features

- Can accommodate an adjustable keyboard tray with attached mouse pad *(optional purchase)*
- Locking file drawers with full-extension ball bearing drawer slides.
- Baltic birch plywood dovetail drawers.
- Constructed of heavy duty $\frac{3}{4}$ " birch MDF.
- Fixed shelving on the bookcases.
- Mahogany, Walnut, Antique White and Black finish available.
- Custom colors available. Contact your sales representative for pricing.
- Now featuring black laminate tops for a more durable work surface. *(as pictured in Antique White photo above)*

** May special order different styles of finish hardware*

LEGACY SERIES

Office Furniture

DESKS

CREDENZAS

HUTCHES



STANDARD DESK
 26D x 62W x 30H
 10-L-SDM
 10-L-SDW
 10-L-SD-BLK
 10-L-SDA
\$919



OFFICE CREDENZA
 19D x 62W x 30H
 10-L-OCM
 10-L-OCBLK
 10-L-OCW
 10-L-OCA
\$790

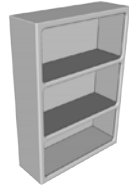

LATERAL FILE HUTCH
 12D x 35W x 48H
 10-L-LFHM
 10-L-LFHW
 10-L-LFHBLK
 10-L-LFHA
\$270



SINGLE PEDESTAL (LEFT / RIGHT RETURN)
 66 x 74 OVERALL
 10-L-SPSD-LM
 10-L-SPSD-LW
 10-L-SPSD-LBLK
 10-L-SPSD-LA
 10-L-SPSD-RM
 10-L-SPSD-RW
 10-L-SPSD-RBLK
 10-L-SPSD-RA
\$1,089

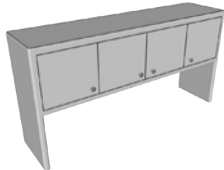

FOUR DOOR HUTCH
 15D x 60W x 36H
 10-L-H4M
 10-L-H4W
 10-L-H4BLK
 10-L-H4A
\$444



STAND ALONE DESK (LEFT / RIGHT RETURN)
 19D x 50W x 30
 10-L-RTN-SA-LM
 10-L-RTN-SA-LW
 10-L-RTN-SA-LBLK
 10-L-RTN-SA-LA
 10-L-RTN-SA-RM
 10-L-RTN-SA-RW
 10-L-RTN-SA-RBLK
 10-L-RTN-SA-RA
\$515

FEATURES

CAN ACCOMMODATE AN ADJUSTABLE KEYBOARD TRAY WITH AN ATTACHED MOUSE PAD

LOCKING FILE DRAWERS WITH FULL-EXTENSION BALL BEARING DRAWER SLIDES

LAMINATE TOP IS SCRATCH, STAIN AND MAR RESISTANT

BALTIC BIRCH PLYWOOD DOVETAIL DRAWERS

CONSTRUCTED OF HEAVY DUTY 3/4" BIRCH MDF

FIXED SHELVING ON THE BOOKCASES

MAHOGANY, WALNUT, ANTIQUE WHITE AND BLACK FINISH AVAILABLE.

CUSTOM COLORS AVAILABLE. CONTACT YOUR SALES REPRESENTATIVE FOR PRICING.

FINISHES



MAHOGANY



WALNUT

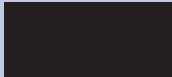

BLACK



ANTIQUE WHITE

Office Furniture



LATERAL FILE 2 DRAWER
 19D x 36W x 32H
 10-L-LF2M
 10-L-LF2W
 10-L-LF2BLK
 10-L-LF2A
\$603



BOOKCASES
 72 Inch Height
 12D x 36W x 72H
 10-L-BK72M
 10-L-BK72W
 10-L-BK72BLK
 10-L-BK72A
\$373



OCCASIONAL TABLE
 17W x 20D x 23H
 10-L-OTM
 10-L-OTW
 10-L-OTBLK
 10-L-OTA
\$192

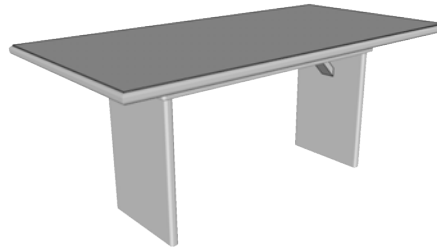

CONFERENCE TABLES
 36D x 72W x 30H
 10-L-CT36/72M
 10-L-CT36/72W
 10-L-CT36/72BLK
 10-L-CT36/72A
\$490



1



2



1



2



3



1

OIL RUBBED BRONZE
 (STANDARD ON WALNUT & MAHOGANY FINISH)

2

BRUSHED NICKEL
 (STANDARD ON BLACK FINISH)

3

BLACK
 (STANDARD ON ANTIQUE WHITE)

NOTE:
 Last letters of catalog number indicate stain color and/or style

M = Mahogany
W = Walnut
BLK = Black
L = Left
R = Right

REPLACEMENT KEYS
 for wood suite furniture
 10-Keys
\$6.00 for a set of two

Keyboard Tray



Catalog #	Description	Price
10-KBDX	Deluxe keyboard tray	\$ 250

Comes fully loaded, with wrist pads and advanced ADA spring assist.

It also has a locking level for convenient positioning, and the mouse pad is felt covered and can be placed on the right or left.

SEATING

Traditional • Ergonomic • Stacking

It seems that many people under-estimate the importance of a good quality office chair. Considering you spend so much time sitting in your office chair on a daily basis — how that chair supports you and performs should not be taken lightly. KCI can provide your quality seating solutions in a full range of options: *classic traditional upholstered, student seating, ergonomic, task and stack seating, occasional, and lounge.* We even provide a great selection of fabrics to choose from, no matter what your style or budget requires.



**BEAUTY
FUNCTION
COMFORT**



• PRICES SUBJECT TO CHANGE WITHOUT NOTICE •



March 20, 2023

Mary M. Jennings
Administrative Branch Manager (Fiscal)
Kentucky Correctional Industries
1041 Leestown Road
Frankfort, KY 40601-8821

RE: Sole Source – OEI Division Products

The OEI Division of Krueger International, Inc. is pleased to offer our various office furniture product lines to Kentucky Correctional Industries. OEI is the sole distributor of these KD (knocked-down) products and markets them exclusively to correctional industry programs. These products were developed and priced by OEI exclusively for manufacture by correctional industries programs across the country. These product lines are not distributed through any type of dealer network; they are not marketed commercially and are not available to the general public.

The unique features of these office furniture product lines are not available from any other vendor. The OEI Division of Krueger International, Inc. is the sole source for these products and is the only distributor of these products.

Please contact me at (920) 468.2298 if you have any questions regarding the above or if you require additional information.

Thank you.

Sincerely,

A handwritten signature in black ink that reads 'Paul VanCamp'.

Paul VanCamp
OEI Administrative Manager

CC: C.A. Wilkerson



Products represented by Bay Product Development, LLC, dba Bay Product, are exclusively available to Correctional Industry programs.

Through Bay Product, Kentucky Correctional Industries has access to all finished products, components, sub-assemblies, and materials Bay Product offers.

All of our manufacturing partners operate under an exclusive partnership, representation and/or distribution agreement designed to provide proper support and pricing to Correctional Industry programs across the country.

Bay Product is designed solely to support Correctional Industries and their mission, while creating a responsible sourcing relationship and providing the necessary support and training services required to successfully support the end user customers.

Individual exclusivity agreements for Correctional Industries, agreed on between Bay Product Development, LLC and each partner supplier, are available upon request.

Best Regards,

A handwritten signature in black ink, appearing to read "K. Schneider", is positioned above the typed name.

Kyle Schneider
President/Partner
Bay Product Development, LLC Office: (303) 962-6770
Mobile: (612) 481-5953
Fax: (720) 389-8329 kyle@bayproductdevelopment.com

4399 S Broadway
Englewood, CO 80113

TRADITIONAL

Timeless Elegance

EXECUTIVE CHAIRS

Catalog #	Description	Price
30-LSCC-5889	Executive Medium Back Low Arms	\$695
30-LSCC-5889-HB	Executive High Back Low Arms	\$769
30-LSCC-5889-EMB	Customized Embroidered Logo <i>minimum 20 chairs</i>	\$730



Features

- Select Kiln-Dried Hardwoods
- Untufted Seat and Back
- Steel Base w/ Maple Overlay
- Swivel w/ Height Adjust
- Tilt Control

Dimensions

38.5 - 41.5H x 24.5W x 29D
 Arm Height: 23"
 Seat Height: 19" - 22"



BANKERS CHAIRS*

Catalog #	Description	Price
30-LSCC-5100	Bankers Chair <i>(shown right)</i>	\$612
30-LSCC-5100-C	Bankers Chair w/Casters*	\$638
30-LSCC-5100-PED	Bankers Chair on Pedestal base w/casters**	\$758

Features

- Select Kiln-Dried Hardwoods
- Brass Nail Head Trim
- Contoured Barrel Back
- Elegant Tapered Legs

Dimensions

30H x 24.5W x 24D
 Arm Height: 25.5"
 Seat Height: 19.5"



* This chair is available with carpet casters or hard surface casters at an additional charge.

** This chair is also available on a pedestal base with casters.

Fabrics shown are examples only.

TRADITIONAL



CAMEL BACK SOFA

Catalog #	Description	Price
30-LSCC-4200	Camel Back Sofa	\$1840

Features

- High Rolled Arms - Sofa and Love Seat
- Chippendale Square Leg
- Kiln-dried Hardwood Frame
- Untufted

Dimensions

36H x 82W x 33D
 Arm Height: 30"
 Seat Deck Height: 20"

BENCH

Catalog #	Description	Price
30-LSCC-503	Bench	\$389



Fabrics shown are examples only.

LOUNGE AND RECEPTION

The ultimate in comfortable, high class reception and lounge seating. Creating an atmosphere of contemporary elegance unmatched in today's business world.

Experience the added benefit of exceptional value versus purely functional furniture. There is no other seating available today that can bring you the satisfaction that this ultra-comfort line will give you now and far into the future. Each frame is constructed with kiln-dried hardwoods specifically selected for their high resiliency which is perfect for busy, high use areas. This will certainly be one of the wisest purchase decisions that you'll ever make for your home or business.

CONTEMPORARY SOFA

Catalog #	Description	Price
30-LSCC-17004-CS	Contemporary Sofa	\$1678



Features

- Slope Arms
- 2" x 2" High Rounded Feet
- Upholstered Spring Back & Seat

Dimensions

Width: 77" Depth: 35"
 Seat Height: 19"
 Arm Height: 25"
 Overall Height: 32"



CONTEMPORARY LOVE SEAT

Catalog #	Description	Price
30-LSCC-89004-CS	Contemporary Sofa	\$1680
30-LSCC-89004-LS	Contemporary Love Seat	\$1440

Sofa Dimensions

Width: 77" Depth: 36"
 Seat Height: 18.5"
 Arm Height: 27.5"
 Overall Height: 35"

Loveseat Dimensions

Width: 60" Depth: 36"
 Seat Height: 18.5"
 Arm Height: 27.5"
 Overall Height: 35"

Fully upholstered with tight back and loose cushions. Springs for added support and comfort.

Fabrics shown are examples only.

LOUNGE AND RECEPTION

Contemporary Style & Comfort

Catalog #	Description	Price
30-LSCC-7401-CLC	Contemporary Armless Chair	\$818

Dimensions

Width: 24" Depth: 35"
 Seat Height: 19"
 Arm Height: 37"



Catalog #	Description	Price
30-LSCC-2475-CLC	Contemporary Lounge Chair	\$912

Dimensions

Width: 31" Depth: 31"
 Seat Height: 19"
 Arm Height: 26.5"



Catalog #	Description	Price
30-LSCC-3650-CLC	Contemporary Lounge Chair	\$527

Dimensions

Width: 22" Depth: 26"
 Seat Height: 20"
 Arm Height: 26"



Catalog #	Description	Price
30-LSCC-2485-CLC	Contemporary Lounge Chair	\$942

Dimensions

Width: 32" Depth: 34"
 Seat Height: 18"
 Arm Height: 25.5"

Fabrics shown are examples only.

Alt3 Seating



Mesh Task Chair

Alt3 is the alternative to one design fits-all seating. Because each of its 3 models employs an independent design, Alt3 task and Conference chairs are free to maximize user comfort and support without restriction.

For the fabric task chair, comfort starts with its sculptural open-frame back detail. Not only does this “exoskeleton” provide necessary support and rigidity for the structure, it allows the upholstered back to flex creating automatic lumbar support.

The Alt3 Mesh Task Chair and Conference Chair pursue the comfort and support goal from a completely different angle, offering up elastomeric mesh over a reinforced frame. The mesh provides flexibility, while the frame supplies the rigidity required for real support.

Seat-height controls are also located beneath the seat of all Alt3 chairs for easy operation. For even more supportive comfort the Fabric and Mesh task chairs is also available with an adjustable headrest and arms. The arms adjust vertically and horizontally.

Variety of fabric colors & patterns available.



Conference Chair



Fabric Task Chair

Catalog #	Description	Price
16-ALT3-1	Fabric Task Chair w/ Adjustable T- Arms, Uph. Seat & Back w/Black Frame	\$710
16-ALT3-2	Mesh Task Chair w/ Adjustable T- Arms, Mesh Back, Uph. Seat & Black Frame	\$700
16-ALT3-3	Conference Chair Fixed Loop Arms, Mesh Back, Uph. Seat & Black Frame	\$432

ATTAIN SEATING



Weight rating: 400

Dimensions

Seat Width: 18"
Overall Width: 27-1/2"
Seat Depth: 18"
Overall Depth: 27-1/2"
Seat Height: 17-1/4" - 22-1/4"

Attain's simple, elegant design suits a wide array of spaces. Suitable for conference rooms, classrooms, computer labs, multipurpose spaces, among others.

Attain comfort begins with a contoured back and seat that fully support the body at rest. A flex back design allows relaxation without requiring any adjustment, & a waterfall seat edge dissipates pressure.

Catalog #	Description	Price
16-ATTAIN-1	4 Leg, Cantilever arm, poly seat & back, plastic glides	\$156
16-ATTAIN-2	4 Leg, Armless, poly seat & back, plastic glides	\$119
16-ATTAIN-3	4 Leg, Cantilever arm, uph seat, poly back, plastic glides	\$193
16-ATTAIN-4	4 Leg, Armless, uph seat, poly back, plastic glides	\$155
16-ATTAIN-5	4 Leg, Cantilever arm, uph seat & back, plastic glides	\$229
16-ATTAIN-6	4 Leg, Armless, uph seat & back, plastic glides	\$180
16-ATTAIN-7	Sled base, Armless, poly seat & back, plastic glides	\$144
16-ATTAIN-8	Sled base, Armless, uph seat & back, plastic glides	\$187
16-ATTAIN-9	Nesting, Armless, uph seat & back, H/Wood casters	\$304

Breathe Task Seating



Dimensions

- Seat Width: 21-5/8"
- Overall Width: 22-3/8"
- Seat Depth: 19-7/8"
- Overall Depth: 25"
- Seat Height: 25-1/4" - 35-1/2"
- Weight Rating: 300

Today’s fast-paced office is the perfect place for the contemporary style and unmatched comfort of Breathe Seating. Sleek styling makes the high-back task chair or stool at home in any organization.

The Breathe line features a sculpted polypropylene back structure wrapped with a double layer of nylon mesh fabric for ultimate support and breathability. A contoured foam seat covered with same soft and durable 2-ply athletic mesh improves ventilation and reduces fatigue.

For even more comfort, users can adjust the seat height and back tension of the chairs with an easily accessible knob and level beneath the seat. The line also includes an adjustable lumbar pad that is built into the chair frame for extra durability.

Lastly, the Breathe task chairs and stools feature a synchronous knee-tilt mechanism with a 2:1 (back-to-seat) ratio. The tilt-lock level can be set in any of 3 lock positions or remain unlocked, allowing the seat to free float.



Breathe Stool



Dimensions:

- Seat Width: 21-5/8"
- Overall Width: 22-1/8"
- Seat Depth: 18-5/8"
- Overall Depth: 25-1/2"
- Seat height: 18-5/8" - 21-3/16"
- Weight Rating: 300 lbs.

Catalog #	Description	Price
16-Breathe-1	Pedestal base, no arms, mesh back & upholstered seat	\$496
16-Breathe-2	Pedestal base, with arms, mesh back & upholstered seat	\$572
16-Breathe-3	Pedestal base, with arms, mesh back & upholstered seat & headrest	\$648
16-BreatheJR	Breathe Junior, no arms mid-back	\$294
16-BreatheJR-2	Breathe Junior, with arms mid-back	\$369
16-Breathestool-1	Breathe Task Stool, no arms, mesh back & upholstered seat	\$534
16-Breathestool-2	Breathe Task Stool, with arms, mesh back & upholstered seat	\$598
16-Breathestool-3	Breathe Task Stool, with arms, mesh back, upholstered seat & headrest	\$671

DANA

Executive Leather Conference Chair



Dana was designed using a Design for the Environment (DFE) design approach. During this process, all components were screened to identify and assess the human and ecosystem health impacts of the ANSI/BIFMA e3 2019 Annex B- List of chemicals proposition 65 List.

Dana has been tested in accordance with ANSI/BIFMA Standard Method M7.1-20011 (R2016) and complies with ANSI/BIFMA e3-2019e Furniture Sustainability Standard, Section 7.6.1,7.6.2, and 7.6.3

Dimensions

Overall: 26"W X 28"D X 39-44"H
 Back Cushion: 20.5"W X 25.5"H
 Seat Cushion: 20"W X 19"D
 Weight Rating: 275 lbs.

Dana is BIFMA Level @ certified.
 Dana is Clean Air Gold certified / certified low emitting.
 Dana is Health Care Without Harm compliant (HHI compliant).



Catalog #	Description	Price
16-DANA	High Back, Leather Seating	\$285

ECLIPSE

Executive High Back Mesh Seating



Dimensions

Height 47"-52"
Width 26"
Depth 22"

Features

2" Ht. Adj. Head Rest
3" Ht. Adj. Fold "Back Arm
Full Function Synchro Tilt
Seat Slider
Nylon Base

Catalog #	Description	Price
16-ECLIPSE	Executive high back mesh seating	\$583

TOTAL ECLIPSE

Large Occupant Ergonomic Seating

24/7 High Volume
500 lb tested

Full Function Adjustable Arms
BIFMA X 5.11 Certified for Large
Occupant Sitting

Height Adjustment Back

Contrasting or Matching Stitching

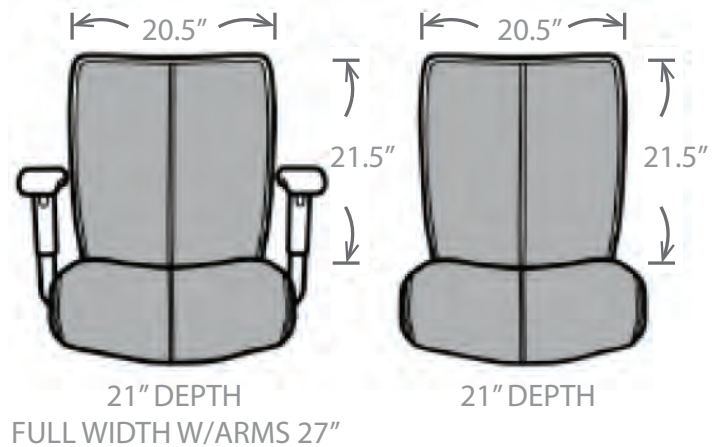

5 Prong Molded Nylon Base
(18.5"H-22.5"H)

60mm Dual Wheel Casters

Catalog #	Description	Price
16-TOTAL ECLIPSE	Heavy duty 24/7, adjustable, upholstered back & seat	\$693

GRIFFIN

Executive Leather Conference Chair



Dimensions

Overall: 25.5"W x 28.5"D x 40"-4
Seat Height: 18.5"-22.5"
Seat Cushion: 20.5"W x 20.75"
Back Size: 20.5"W x 28.75"H
Net Weight: 38.5 lbs.

Griffin has been tested in accordance with ANSI/BIFMA Standard Method M7.1-2011 (R2016) and complies with ANSI/BIFMA e3-2019e Furniture Sustainability Standard, Sections 7.6.1, 7.6.2, and 7.6.3.

Griffin is BIFMA LEVEL 2 certified.

Griffin is CLEAN AIR GOLD certified.

Griffin is Health Care Without Harm compliant (HHI compliant)



Catalog #	Description	Price
16-GRIFFIN	Executive leather conference chair	\$416

ITHACA ULTRA

Seating



Mid-back

Variety of fabric colors and patterns available.

Height Adjustable
T-arms
or
loop arms available



Stool

Because even an accommodating design doesn't suit every application, the Ithaca Ultra is available in multiple configuration. The mid-back task chair has the same complement of adjustments and arm options as the high-back but its additional back height adjustability ensures ideal lumbar support.

The Ithaca Ultra stool also features seat height adjustability and a reclining mechanism with a back tilt lock. An oversized 5-star base and adjustable steel foot ring provide increased stability and security over the its 22-1/4" to 30" height range.

The Ithaca Ultra guest chair may rely upon its sturdy sled base and subtle curves to attract attention, but that doesn't mean it is short on thoughtful features. The mesh back is height-adjustable, and the non-marring poly glides provide stability on a variety of floor surfaces. Even at its most basic, Ithaca Ultra is the smart choice in innovative design.

Catalog #	Description	Price
16-ITHACA ULTRA-1	Mid Back Chair, Adjustable T-Arms, Mesh Back, Uph. Seat & Black Frame	\$534
16-ITHACA ULTRA-2	Mid Back Chair, Fixed Loop Arms, Mesh Back, Uph. Seat & Black Frame	\$530
16-ITHACA ULTRA-6	Stool Chair, No Arms, Mesh Back, Uph. Seat & Black Frame	\$507
16-ITHACA ULTRA-7	Stool Chair, Adjustable T-Arms, Mesh Back, Uph. Seat & Black Frame	\$614
16-ITHACA ULTRA-8	Stool Chair, Fixed Loop Arms, Mesh Back, Uph. Seat & Black Frame	\$611

Maximus

Large Occupant Executive Seating



Features

- Coiled Spring Seat
- Big and Tall Gas Lift
- Big and Tall Casters
- Big and Tall Base

24/7 High Volume
500 lb tested

Dimensions

Overall: 29.1"W x 29.1"D x 42"-46"H
Seat Height: 20"-23.6"
Seat Cushion: 23.8"W x 19"D
Back Size: 23.6"W x 32.3"H
Net Weight: 28.3 lbs.

Catalog #	Description	Price
16-MAXIMUS	Heavy Duty Task Chair, Leather, Big & Tall, Gas Lift	\$664

Navigator Air Task Seating

Spontaneous Seating

Impromptu meeting in your office? No problem, Navigator seats flip-up and chairs nest for easy, out of the way storage. When needed for that spur of the moment meeting, Navigator seating rolls into action.

Comfortable Seating

Whether you need a chair for an eight-hour training session or a two-minute conference, Navigator provides exceptional comfort. Outstanding comfort is due to its flexing back and its thick seat cushion.

Navigator Seating

It will change the way you look at seating. Whether you need a training room chair, conference chair, guest chair or . . . whatever, Navigator Seating accommodates.

Navigator Seating is available, “when you need it – where you need it.” Easy to store, thanks to its nesting capability. Easy to move - thanks to it’s caster design.



**16 BACK & SEAT
POLY COLORS
AVAILABLE**

Features

**Flex back
Flip-up Seat
Casters
Nests**



Dimensions

Width: 23.5”
Depth: 24.2”
Height: 32.25”

Fabrics shown are examples only. SCS Certified.

Catalog #	Description	Price
16-NAV1	Navigator, no arms, poly back, upholstered seat	\$312
16-NAV2	Navigator, no arms, upholstered back and seat	\$ 332
16-NAV3	Navigator, with arms, poly back, upholstered seat	\$ 341
16-NAV4	Navigator, with arms, upholstered back and seat	\$ 362

Navigator Air Task Seating



Dimensions

Seat Width: 17"
 Overall Width: 27 1/2"
 Seat Depth: 18 1/2"
 Overall Depth: 26 1/2"
 Seat Height: 23"-33 1/4"
 Weight Rating: 300 lbs.

Navigator Air chairs and stools take comfort to a whole other level by mixing an upholstered cushioned seat with a breathable mesh back.

The contoured frame of the back provides lumbar support, while the open weave of the polyester mesh allows air to circulate more freely for greater thermal comfort.

The Navigator Air seating family does more than incorporate modern materials; it projects a modern aesthetic. Details like the black and grey mesh option and the cantilevered fixed arms reinforce the seating's bold geometry and stark color palette.

As important as how the furniture looks, is how it makes you feel. Navigator Air task seating ensures you will always be able to find a comfortable seat effortlessly.

A torsion-bar mechanism gradually increases the resistance as you recline— no tension knob required. The only control below the seat is for the seat height because with Navigator Air, that is only adjustment you need to make.

Catalog #	Description	Price
16-Navstool-1	Navigator Air Stool with arms, upholstered seat, mesh back	\$372
16-Navstool-2	Navigator Air Stool no arms, upholstered seat, mesh back	\$ 353
16-Navtask-1	Navigator Task Chair no arms, upholstered seat, mesh back	\$ 240
16-Navtask-2	Navigator Task Chair with arms, upholstered seat, mesh back	\$ 292

Features

- Swivel/Height Adjustment
- Fixed Cantilever Arms
- Modern Mesh Back (Black or Grey)
- Torsion Back Articulation

Dimensions

Seat Width: 17"
 Overall Width: 26 1/2"
 Seat Depth: 18 1/2"
 Overall Depth: 26 1/2"
 Seat Height: 18-23"
 Weight Rating: 300 lbs.



OCCUPY TASK SEATING

These task chairs and stools have self-weighting mechanisms that calibrate reclining resistance to the user's weight, plush molded foam seats and mesh backs that provide intuitive comfort. Adjustable seat and arm height ensures appropriate fit. The 5-star base with 26" diameter provides stability without making the chair or stool unwieldy.

Dimensions

Seat Width: 20"
Overall Width: 27-1/2"
Seat Depth: 19"
Overall Depth: 26"

Weight rating: 300



Catalog #	Description	Price
16-OCCUPY-1	Occupy chair, no arms, mesh back	\$ 361
16-OCCUPY-2	Occupy chair, with arms, mesh back	\$ 406
16-OCCUPYSTOOL-1	Occupy stool, no arms, mesh back	\$ 427
16-OCCUPYSTOOL-2	Occupy stool, with arms, mesh back	\$ 473

PILOT™

PILOT XL SEATING WITH LOOP OR T-ARMS

You don't just need a task chair that the "average employee" will be comfortable in, you need a task chair that YOU will be comfortable in - all the time. If you have found that other chairs just don't measure up, **Pilot XL** is ready to welcome you aboard.

Big and tall users will appreciate its expansive 24" wide seat, which like the Pilot Task Chair and Stool, features a waterfall edge to relieve pressure on the thighs and high back that provides gentle support to the entire spine. To further prevent fatigue, layers of plush, resilient foam envelop both the seat and back.

Because it was designed for round-the-clock use, **Pilot XL** won't just be comfortable the first time you use it, it will be comfortable every time. A heavy-duty frame including an oversized steel J-bar and reinforced mechanism guarantee it.

With so many reasons to make Pilot seating your own, the only decision you need to make is where you want it to take you.



Height adjustable arms

Fixed loop arms

Break-away arms

Fabrics shown are examples only.



Fixed loop arms give **Pilot™** a traditional task chair look and feel.



Adjustable loop arms can be adjusted 2.5" in height for maximum comfort.



Pilot's multifunctional mechanism allows you to free float, lock the seat back in a reclined position or lock just the back angle.



Striking from top to bottom, **Pilot XL** features heavy-duty, two-tone universal casters for both hard and soft floors.

Catalog #	Description	Price
16-PILOT/247	Pilot XL with Loop or T-Arms (specify arm preference)	\$ 1,198

SCS Certified.

PIPER®

Piper® is an affordable, high-density stack chair which doesn't look like a high density stack chair. It's superior construction ensures years of trouble-free use.



Dimensions

Width: 19.25"
Depth: 21.25"

Piper® Stack Chair
Stylish. Durable. Affordable.
SCS Certified

POLYPROPYLENE SEAT AND BACKREST AVAILABLE IN THE FOLLOWING COLORS:

BLACK	DARK BLUE GREEN	SPLASH	DARK BLUE
BLUE GREY	DEEP DEEP GREY	SUNBURST	SAND
BORDEAUX	GRAPE	TANGELO	WET SAND
CAYENNE	LIGHT TONE	WARM GREY	CHOCOLATE



- A transport dolly is available for convenient stacking and storage
- Allows for 38 stacked chairs to pass through a standard doorway

Guide Options

Stainless steel, black PVC, clear polycarbonate, ganging polycarbonate & ganging stainless steel glide options are available for Piper Seating. The following grid shows floor type application rating recommendations for each glide.

Floor Type	Glide Type (Narrow)			
	Polycarbonate	Stainless Steel	Non-Skid (PVC) Dual Durometer	NoGlide
Vinyl Sheet/Tile	N/R	N/R	Excellent	N/R
Vinyl Composite Tile	N/R	Good	Excellent	N/R
Hardwood	N/R	Good	Excellent	N/R
Concrete	N/R	Good	Excellent	N/R
Ceramic	Excellent	Good	Excellent	N/R
Marble	N/R	N/R	Good	N/R
Carpeting	Excellent	Excellent	N/R	Excellent

RATINGS GUIDE:
Excellent - No visible trace
Good - Visible trace, no permanent damage to floor
N/R - Not recommended

Catalog #	Description	Price
16-PIPER-1GPG	Piper chair with ganging polycarbonate glides	\$ 95
16-PIPER-2GSG	Piper chair with ganging steel glides	\$ 95
16-PIPER-3PG	Piper chair with polycarbonate glides	\$ 86
16-PIPER-4NG	Piper chair without glides	\$ 80
16-PIPER-5NSG	Piper chair with PVC non-skid glides	\$ 95
16-PIPER-6SSG	Piper chair with stainless steel glides	\$ 86
16-PIPER-F	Piper chair with fabric	\$ 138
16-PIPER-TD	Piper transport dolly	\$ 260

Run II



Features

- Seat Style: Mid-back model.
- Arms: Are ergonomic adjustable height arm featuring a sleek, textured large cap arm width adjustment available in black.
- Control mechanisms: Full function ergonomic synchro control mechanism with easy to use side tension adjustment.
- Mesh: 4-way stretch elastomeric mesh including patented, self-sanitizing, biocidal copper-infused mesh option.
- Seating’s comfort foam: A proprietary blend of high-density, injection-molded, closed-cell, cold-cured comfort foam so durable and long lasting.
- Max Weight: 300 lbs.

Run II was designed using a Design for the Environment (DFE) design approach. During this process, all components were screened to identify and assess the human and ecosystem health impacts of the ANSI/BIFMA e3 2019 Annex B– List of chemicals proposition 65 List.

Run II has been tested in accordance with ANSI/BIFMA Standard Method M7.1-20011 (R2016) and complies with ANSI/BIFMA e3-2019e Furniture Sustainability Standard, Sec-ton 7.6.1,7.6.2, and 7.6.3

Run II is BIFMA Level @ certified.

Run II is Clean Air Gold certified / certified low emitting.

Run II is Health Care Without Harm compliant (HHI compliant).



Catalog #	Description	Price
16-RUN II	Mid-Back, Mesh,Black Arm, Black Frame & Black Caster	\$ 443

SNAP TASK SEATING

Stylish Affordable Ergonomic

Snap seating offers so much more than your average task chair. Because of its foam construction, lumbar pillows for back support, sculpted seat, and the perfect comfort combination of soft seat and firm back, Snap chairs are the most comfortable chairs in their price range.

Beyond its construction, Snap seating delivers a multitude of adjustments to fit the needs of individual users. Snap allows users to adjust back height, back pivot and arm height.

It's more than you would expect from a value line of seating. This version of Snap seating is the ultimate high back task seating with advanced function height and width adjustable t-arms and five hard floor casters.



Height and width adjustable t-arms



Contoured seat and back cushions add comfort and durability.



Fully height adjustable. The pivot mechanism fits the needs of the individual user.

Fabrics shown are examples only.

SCS Certified.



task chair



snap stool with t-arms



snap stool without t-arms

Catalog #	Description	Price
16-SBS-TA	26" base in chrome or plastic with t-arms	\$ 399
16-SBS-NA	26" base in chrome or plastic without t-arms	\$ 371
16-STC	Snap T-Arms Task Chair	\$ 341



TABLES



FIXED LEG



FOLDING LEGS

PORTICO TABLES

FIXED LEG



Everyday Value

Offering clean and simple design, KCI's indoor fixed leg tables complement any environment and provide exceptional durability. Trust KCI to be the right choice for today and many years to come.



Portico tables are available in a variety of shapes, sizes and leg styles.



Colored end caps and trim pieces provide subtle accents and sharp contrast.

PORTICO TABLES

FIXED LEG



Optional PowerUp units provide convenient work surface access to power and data.



All KCI's fixed leg table have a ¼" vinyl bull nose edge.

SCS Certified

Rectangular Fixed Leg Tables		
Catalog #	Size	Price
19-P154F/54B	18" W x 48" L	\$ 274
19-P155F/54B	18" W x 60" L	\$ 289
19-P156F/54B	18" W x 72" L	\$ 306
19-P157F/54B	18" W x 84" L	\$ 321
19-P158F/54B	18" W x 96" L	\$ 338
19-P24F/54B	24" W x 48" L	\$ 294
19-P25F/54B	24" W x 60" L	\$ 314
19-P26F/54B	24" W x 72" L	\$ 334
19-P27F/54B	24" W x 84" L	\$ 356
19-P28F/54B	24" W x 96" L	\$ 376
19-P254F/54B	30" W x 48" L	\$ 322
19-P255F/54B	30" W x 60" L	\$ 276
19-P256F/54B	30" W x 72" L	\$ 376
19-P257F/54B	30" W x 84" L	\$ 399
19-P258F/54B	30" W x 96" L	\$ 426
19-P34F/54B	36" W x 48" L	\$ 343
19-P35F/54B	36" W x 60" L	\$ 375
19-P36F/54B	36" W x 72" L	\$ 405
19-P37F/54B	36" W x 84" L	\$ 436
19-P38F/54B	36" W x 96" L	\$ 465

Round Fixed Leg Tables		
Catalog #	Size	Price
19-PR-25FX/54B	30" Round	\$ 275
19-PR-3FX/54B	36" Round	\$ 312
19-PR-35FX/54B	42" Round	\$ 345
19-PR-4FX/54B	48" Round	\$ 487
19-PR-5F/54B	60" Round	\$ 576

All Portico style tables come with a custom stylish laminate top.

Square Fixed Leg Tables		
Catalog #	Size	Price
19-PS-25FX/54B	30" Square	\$ 275
19-PS-3FX/54B	36" Square	\$ 312
19-PS-35FX/54B	42" Square	\$ 345
19-PS-4FX/54B	48" Square	\$ 487

ULTRALITE FURNITURE

FOLDING LEG



Top Color is Light Gray! Frame & Legs in Black Only

Catalog #	Description	Price
19-REC30X60	Rectangular table 30" x 60"	\$173
19-REC30X72	Rectangular table 30" x 72"	\$200
19-REC30X96	Rectangular table 30" x 96"	\$260
19-ROU48	Round table 48"	\$212
19-ROU60	Round table 60"	\$339
19-ROU71	Round table 71"	\$453

Catalog #	Price
19-FOLDING CHAIR	\$ 90.00



SCS Certified

CORRECTIONAL FURNITURE



• **PRICES SUBJECT TO CHANGE WITHOUT NOTICE** •

CORRECTIONAL FURNITURE

Metal Bunks with 27" wide mattress holders (order TV trays from list below)



Catalog #	Description	Size
14-B-7001	75" single floor mounted bunk 16 gauge	27"W x 75"L
14-B-8001-W	75" wall mounted single bunk 11 gauge	27"W x 75"L
14-B-9011-W	80" wall mounted bunk 11 gauge	27"W x 75"L
14-B-8003-F	75" single floor mounted bunk 11 gauge	27"W x 75"L
14-B-8004-F	75" double floor mounted bunk 11 gauge (52" legs will not accept TV trays)	27"W x 75"L
14-B-8004-F-TV	75" double floor mounted bunk 11 gauge (58" legs will accept TV trays)	27"W x 75"L
14-B-9013-F	80" single floor mounted bunk 11 gauge	27"W x 80"L
14-B-9015-F	80" double floor mounted bunk 11 gauge (52" legs will not accept TV trays)	27"W x 80"L
14-B-9015-F-TV	75" double floor mounted bunk 11 gauge (58" legs will accept TV trays)	27"W x 80"L
14-B-9021-F	Triple floor mounted bunk 11 gauge with ladder & rails (22" headroom between bunks)	27"W x 75"L

TV Trays jail bunk TV trays priced as set of two trays for one double jail bunk

Catalog #	Description	Size
14-TV-TRAY-JB	Set of two each, add-on (11 gauge) TV trays for double jail bunks 14-B-8004-F-TV or 14-B-9015-F-TV	27"W x 16"D Bunk legs are 58" for extra headroom on lower bunk
14-TV-TRAY-CB	One each add-on (16 gauge) TV trays for lower or upper stackable college beds	36"W x 16"D

**Due to recent tariffs
metal pricing
must be verified
with every order.**

Custom Modular Beds (bolt together units)



*Custom double bunk
with T.V. tray
(sold separately)*

Stackable modular college beds w/ weld & bolted assembly (stack and bolt for a double) Part numbers indicate width x length: i.e., 3680 followed by print #: Example 471 followed by gauge: Example 14BOLT or 14WELD

The stackable college beds below have pan ends bolted to bed pan. Corner gussets are also Bolted to bed leg and frames allowing dismantling to one bed pan, two leg frames & four gussets, for clearing narrow passages upon delivery and reassembling. This design also reduces combined weight when carrying above ground level.

Catalog #	Stackable Beds	Size
14-3680-471-14BOLT	14 ga. single stackable all bolted college bed	36"W x 80"L x 35"H
14-4080-429-14BOLT	14 ga. single stackable all bolted college bed	40"W x 80"L x 35"H

Stackable modular college beds with total welded assembly (stack & bolt for a double)

The stackable college beds below have pan ends & gussets welded to bed pan and leg frames.

14-3680-471-14WELD	14 ga. single stackable all welded college bed	36"W x 80"L x 35"H
14-4080-429-14WELD	14 ga. single stackable all welded college bed	40"W x 80"L x 35"H

When TV trays are required for stackable college beds use catalog # 14-TV-TRAY-CB

Under Bunk Storage

Catalog #	Description	Size
14-1818-BB	Add on double bunk storage cube (1 unit)	18"W x 18"D x 8"H (each unit)
14-1818-BB2	Add on double bunk storage cube (2 unit)	18"W x 18"D x 8"H (each unit)



CORRECTIONAL FURNITURE



Footlocker

Catalog #	Description	Size
14-FL-3115-1216	16 gauge steel footlocker	31"W x 15"D x 12"H
14-FL-3115-1218	18 gauge steel footlocker	31"W x 15"D x 12"H



Mirror

Catalog #	Description	Size
14-M-8510	Stainless steel mirror	10"W x 11.5"H



Nightstand

Catalog #	Description	Size
14-N-7496M	Nightstand with closed base, fiber resin top	15"W x 18"D x 28"H
14-N-7496M-T	Nightstand with closed base, metal top	15"W x 18"D x 28"H



Safety Shelves

Catalog #	Description	Size
14-S-2002-11	Shelf with two safety hooks	18"W
14-S-2003-11	Shelf with three safety hooks	18"W
14-S-2004-11	Shelf with four safety hooks	18"W



Stool

Catalog #	Description	Size
14-S-4511	Stool	12"D x 18"H



Floor Mounted Benches

Catalog #	Description	Size
14-B-3011-12	12" depth metal bench	60"W x 12"D
14-B-3011-15	15" depth metal bench	60"W x 15"D
14-B-3011-18	18" depth metal bench	60"W x 18"D

**Due to recent tariffs
metal pricing must be verified
with every order.**

CORRECTIONAL FURNITURE

Cell Units

Catalog #	Description	Size
14-CU-6615-60-S-DR	Cell unit (no doors) with short dowel area/desk mounted on right side	66"W x 15"D x 60"H
14-CU-6615-60-S-DL	Cell unit (no doors) with short dowel area/desk mounted on left side	66"W x 15"D x 60"H
14-CU-6615-60-L-DR	Cell unit (no doors) with long dowel area/desk mounted on right side	66"W x 15"D x 60"H
14-CU-6615-60-L-DL	Cell unit (no doors) with long dowel area/desk mounted on left side	66"W x 15"D x 60"H

14-CU-6615-60-L-DR

Cell unit with larger dowel area & attached desk on right side

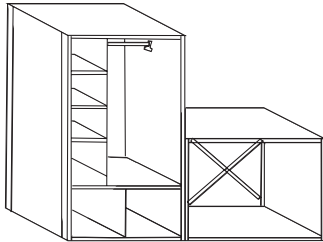

14-CU-6615-60-L-DL

Cell unit with small dowel area & attached desk on right side

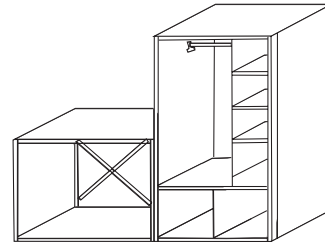

Picnic Style Table w/Bench

Catalog #	Description	Size
14-T-1102-1	Picnic style table with bench (seats 1)	(Top 24"W x 18"D) (Overall 24" W x 39"D)
14-T-1122-2	Picnic style table with bench (seats 2)	(Top 24"W x 24"D) (Overall 24" W x 53"D)
14-T-1144-4	Picnic style table with bench (seats 4)	(Top 48"W x 24"D) (Overall 48" W x 50"D)
14-T-1166-6	Picnic style table with bench (seats 6)	(Top 72"W x 24"D) (Overall 72" W x 50"D)
14-T-1188-8	Picnic style table with bench (seats 8)	(Top 96"W x 24"D) (Overall 96" W x 50"D)



14-T-1122-2

2 Person picnic style table with bench with table

Picnic style table & bench (sits 2 - 8)
Catalog # **14-T-1144-4** thru **14-T-1188-8**

All steel used is 11 gauge unless otherwise noted

**Due to recent tariffs
metal pricing must be verified
with every order.**

METAL PRODUCTS

Lockers • Cabinets • Shelving



When you specialize in manufacturing metal products for a high security environment you tend to build and produce items that are very well made if not practically indestructible.

KCI's lockers, shelving and storage solutions borrow from the heritage of our institutional furniture which is built to last no matter the circumstances or application. These metal lockers, shelving units, and storage cabinets are of uncommon quality and built to perform admirably, well into the future.

**Due to recent tariffs
metal pricing must be verified
with every order.**

• PRICES SUBJECT TO CHANGE WITHOUT NOTICE •

LOCKERS

Single Tier



Single Unit	
Catalog #	Size
14-1212-6011	12 x 12 x 60
14-1215-6011	12 x 15 x 60
14-1212-7211	12 x 12 x 72
14-1215-7211	12 x 15 x 72
14-1518-7211	15 x 18 x 72
14-1821-7211	18 x 21 x 72



Triple Unit	
Catalog #	Size
14-1212-6013	12 x 12 x 60
14-1215-6013	12 x 15 x 60
14-1212-7213	12 x 12 x 72
14-1215-7213	12 x 15 x 72
14-1518-7213	15 x 18 x 72
14-1821-7213	18 x 21 x 72

Double Tier



Single Unit	
Catalog #	Size
14-1212-6021	12 x 12 x 60
14-1215-6021	12 x 15 x 60
14-1212-7221	12 x 12 x 72
14-1215-7221	12 x 15 x 72
14-1518-7221	15 x 18 x 72
14-1821-7221	18 x 21 x 72



Triple Unit	
Catalog #	Size
14-1212-6023	12 x 12 x 60
14-1215-6023	12 x 15 x 60
14-1212-7223	12 x 12 x 72
14-1215-7223	12 x 15 x 72
14-1518-7223	15 x 18 x 72
14-1821-7223	18 x 21 x 72

Features of our lockers, shelving and cabinets include:

- Assembling which makes each product ready to set in place upon delivery.
- Baked-on enamel finish in a variety of colors.
- Shelving comes in 3 categories of weight class and closed or open backs and sides.
- Heavy gauge spot welded and bolted construction lockers.
- Every size and shape to meet your needs.

Order by catalog product number only:

It is only necessary to show the catalog product number and color choice on your order.

Colors: All products have a durable baked-on enamel finish. There are thirty (30) colors to choose from, as shown on pages 65 & 66.

* **Slope tops** and **closed bases** are **optional** with our lockers. Please see our price list, (**page 57**) for various sizes, descriptions, and prices.

**Due to recent tariffs
metal pricing must be verified
with every order.**

LOCKERS

Single Tier Recessed Handle



**Due to recent tariffs
metal pricing must
be verified
with every order.**



Single Unit	
Catalog #	Size
14-1212-6011R	12 x 12 x 60
14-1215-6011R	12 x 15 x 60
14-1212-7211R	12 x 12 x 72
14-1215-7211R	12 x 15 x 72
14-1518-7211R	15 x 18 x 72
14-1821-7211R	18 x 21 x 72

Triple Unit	
Catalog #	Size
14-1212-6013R	12 x 12 x 60
14-1215-6013R	12 x 15 x 60
14-1212-7213R	12 x 12 x 72
14-1215-7213R	12 x 15 x 72
14-1518-7213R	15 x 18 x 72
14-1821-7213R	18 x 21 x 72

Double Tier Recessed Handle



There will be a \$25.00 per hour
(minimum 1 hour) plus parts to
go to the jobsite to repair any KCI
product not under warranty



Single Unit	
Catalog #	Size
14-1212-6021R	12 x 12 x 60
14-1215-6021R	12 x 15 x 60
14-1212-7221R	12 x 12 x 72
14-1215-7221R	12 x 15 x 72
14-1518-7221R	15 x 18 x 72
14-1821-7221R	18 x 21 x 72

Triple Unit	
Catalog #	Size
14-1212-6023R	12 x 12 x 60
14-1215-6023R	12 x 15 x 60
14-1212-7223R	12 x 12 x 72
14-1215-7223R	12 x 15 x 72
14-1518-7223R	15 x 18 x 72
14-1821-7223R	18 x 21 x 72

Athletic Expanded Door

Single Unit	
Catalog #	Size
14-2415-7211-A	24 x 15 x 72
14-2421-7211-A	24 x 21 x 72



Custom Lift Seat athletic locker
with lower recessed pocket and
ventilated storage on all sides.



Double Tier Single Unit	
Catalog #	Size
14-2415-7221-A	24 x 15 x 72
14-2421-7221-A	24 x 21 x 72

Custom Lift Seat Single Tier/Single Unit Athletic Locker with Ventilated Storage	
Catalog #	Size
14-3020-7211-A-V-LIFTSEAT	30 x 24 x 72

LOCKERS

5 Tier Box

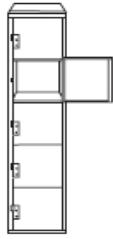

Single Unit	
Catalog #	Size
14-1212-60-5	12 x 12 x 60
14-1215-60-5	12 x 15 x 60



Triple Unit	
Catalog #	Size
14-1212-60-15	12 x 12 x 60
14-1215-60-15	12 x 15 x 60

6 Tier Box

Due to recent tariffs metal pricing must be verified with every order.

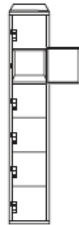

Single Unit	
Catalog #	Size
14-1212-72-6	12 x 12 x 72
14-1215-72-6	12 x 15 x 72

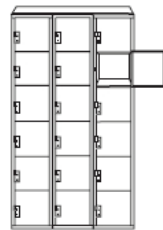

Triple Unit	
Catalog #	Size
14-1212-72-18	12 x 12 x 72
14-1215-72-18	12 x 15 x 72

8 Tier Box



Single Unit	
Catalog #	Size
14-1212-72-8	12 x 12 x 72
14-1215-72-8	12 x 15 x 72



Triple Unit	
Catalog #	Size
14-1212-72-24	12 x 12 x 72
14-1215-72-24	12 x 15 x 72

NOTE:
Overall unit height remains the same, which decreases the size of the individual locker as the number of tiers increases.

LOCKER ACCESSORIES

Slope Tops

Keeps debris and unwanted storage off top of lockers

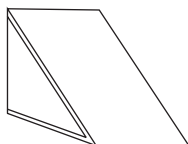

Single Unit	
Catalog #	Size
14-1212-STC	12"W x 12"D
14-1215-STC	12"W x 15"D
14-1518-STC	15"W x 18"D
14-1821-STC	18"W x 21"D

Double Unit	
Catalog #	Size
14-1212-STD	12"W x 12"D
14-1215-STD	12"W x 15"D
14-1518-STD	15"W x 18"D
14-1821-STD	18"W x 21"D



Triple Unit	
Catalog #	Size
14-1212-STT	12"W x 12"D
14-1215-STT	12"W x 15"D
14-1518-STT	15"W x 18"D
14-1821-STT	18"W x 21"D

**Due to recent tariffs
metal pricing must
be verified
with every order.**

Closed Bases

Elevates lockers keeping debris and water from entering

Single Unit	
Catalog #	Size
14-1212-CBS	12"W x 12"D
14-1215-CBS	12"W x 15"D
14-1518-CBS	15"W x 18"D
14-1821-CBS	18"W x 21"D

Triple Unit	
Catalog #	Size
14-1212-CBT	12"W x 12"D
14-1215-CBT	12"W x 15"D
14-1518-CBT	15"W x 18"D
14-1821-CBT	18"W x 21"D

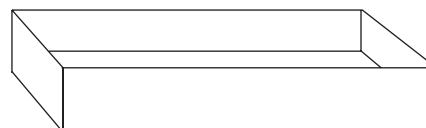
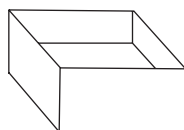

Name Plates

Numerate and/or identify lockers with name plates.



(font shown not actual font used)

Single Unit	
Catalog #	Size
14-PL-85P	N/A

Replacement Keys

All locking on cabinetry may be customized to one key or individually.

Metal Furniture	
Catalog #	Size
19-KEYS	Set of 2

LOCKER INFORMATION

HOW TO READ LOCKER PART NUMBERS

We use “tier” not column and we use “unit” not stack.
For example: Single tier is one door and a double tier is two doors, one above the other.

Also: Single unit is one locker but a triple unit is three lockers bolted together.

Break down of locker part No. 14-1215-7211 (page 54)

14	12	15	72	1	1	No Letter
KSR Metal Plant	Width	Depth	Height	Single Tier	Single Unit	Regular lift handle

Break down of locker part No. 14-1215-7223 (page 54)

14	12	15	72	2	3	No Letter
KSR Metal Plant	Width	Depth	Height	Double Tier	Triple Unit	Regular lift handle

Break down of locker part No. 14-1518-7211R (page 55)

14	15	18	72	1	1	R
KSR Metal Plant	Width	Depth	Height	Single Tier	Single Unit	Recessed Handle

Break down of locker part No. 14-1518-7221R (page 55)

14	15	18	72	2	1	R
KSR Metal Plant	Width	Depth	Height	Double Tier	Single Unit	Recessed Handle

Break down of locker part No. 14-1518-7223R (page 55)

14	12	15	72	2	3	R
KSR Metal Plant	Width	Depth	Height	Double Tier	Triple Unit	Recessed Handle

Break down of locker part No. 14-2415-7211-A (page 55)

14	24	15	72	1	1	A
KSR Metal Plant	Width	Depth	Height	Single Tier	Single Unit	Athletic locker

**Due to recent tariffs
metal pricing must
be verified
with every order.**

METAL CABINETS & WARDROBES

**Due to recent tariffs
metal pricing must be verified
with every order.**

** Standard configuration provides 5 shelves,
unless otherwise noted.
Specify if different number is requested.*

14-3421-36-SC

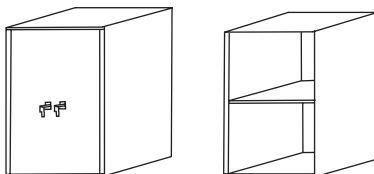

14-2218-72-SC-5

22"W x 18"D x 72" H
Example shown with 1 and 3 shelves.

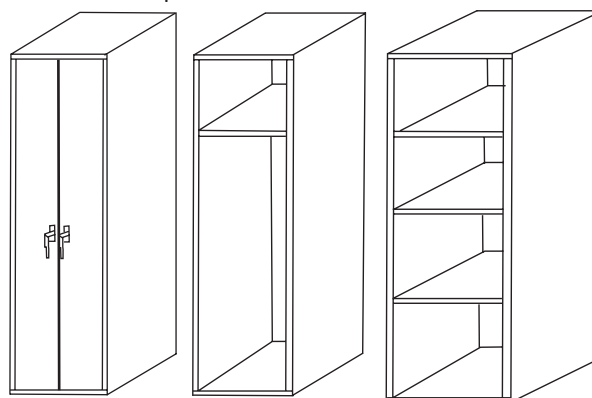

14-3421-72-SC-3

14-3421-72-SC-5

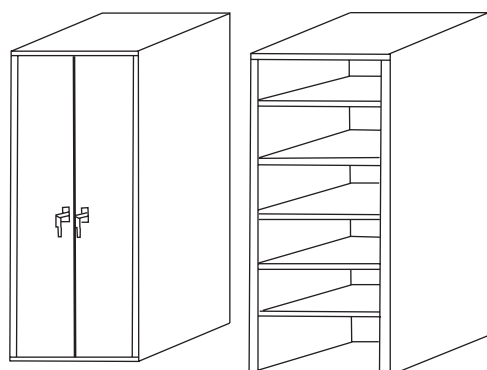

14-2218-72-SC-5 & 14-3421-72-SC-5

*Storage cabinets above are made in the following:
Widths (22", 28", 30", 34") & Depths (15", 18", 21", 24")*

Catalog #	Description	Size
14-3421-36-SC	18 Gauge shelves & 16 gauge two door half storage cabinet with one shelf & locking handle assembly.	34"W x 21"D x 36"H
14-2218-72-SC-1	18 Gauge shelves & 16 gauge two door storage cabinet with one shelf & locking handle assembly.	22"W x 18"D x 72"H
14-2218-72-SC-3	18 Gauge shelves & 16 gauge two door storage cabinet with three shelves & locking handle assembly.	22"W x 18"D x 72"H
14-2218-72-SC-5	18 Gauge shelves & 16 gauge two door storage cabinet with five shelves & locking handle assembly.	22"W x 18"D x 72"H
14-3421-72-SC-3	18 Gauge shelves & 16 gauge two door storage cabinet with three shelves & locking handle assembly.	34"W x 21"D x 72"H
14-3421-72-SC-5	18 Gauge shelves & 16 gauge two door storage cabinet with five shelves & locking handle assembly.	34"W x 21"D x 72"H

The catalog numbers are standard units. Please call for a quote on the other sizes & always list number of shelves per unit.

METAL CABINETS & WARDROBES

Janitorial & PortionPac Cabinets

Due to recent tariffs metal pricing must be verified with every order.

Catalog #	Description	Size
14-3421-72-JPP	Double door janitor's PortionPac cabinet with 3 full width shelves and locking handle assembly	34"W x 21"D x 72"H
14-3421-72-JPP-W	Double door janitor's PortionPac cabinet with 3 21" wide shelves, partition and locking handle assembly	34"W x 21"D x 72"H
14-3624-72-JPP-W	Double door janitor's PortionPac cabinet with 3 24" wide shelves, partition and locking handle assembly	36"W x 24"D x 72"H

14-2218-72-W
Regular wardrobe
double door, 1 full shelf at top
locking handle

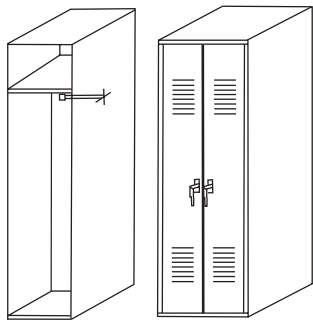

14-2218-72-WDT
Teacher's Wardrobe
double door
locking handle

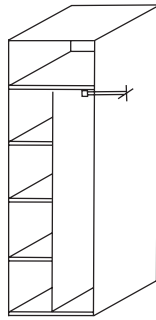

14-2218-72-WC
Cell (dormitory) wardrobes
single door with hasp plate



14-2218-72-WCD **14-2218-78-WCD**
Dormitory cell wardrobes
double door locking handle
78" H unit has a 6" H closed base bottom

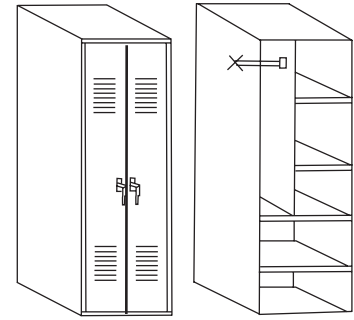

Catalog #	Description	Size
14-2218-72-W	16 gauge double door regular wardrobe with locking handle assembly, one full 18 gauge shelf at top and full open interior	22"W x 18"D x 72"H
14-2218-72-WDT	Double door teacher's wardrobe with locking handle assembly, one full 18 gauge shelf at top, three 22 gauge half shelves & full length dowel area. (Also used by fire departments)	22"W x 18"D x 72"H
14-2218-72-WC	Single door wardrobe, cell with hasp plate for padlock, has short dowel area, two small 22 gauge shelves & two full 22 gauge shelves at the bottom	22"W x 18"D x 72"H
14-2218-72-WCD	Double door wardrobe, cell with locking handle assembly, short dowel area and two full 22 gauge shelves at bottom	22"W x 18"D x 72"H
14-2218-78-WCD	Double door wardrobe, cell with locking handle assembly, short dowel area and two full 22 gauge shelves at bottom	22"W x 18"D x 72"H

Special Note: the term "cell" in the description area is currently used for all wardrobes. This tends to cause confusion. It would be most helpful to not use "cell" when ordering Regular and/or Teacher's Wardrobes. When ordering wardrobes for institutions "dormitory cell wardrobe" could be used to distinguish between the different configurations.

OPEN STEEL SHELVING UNITS

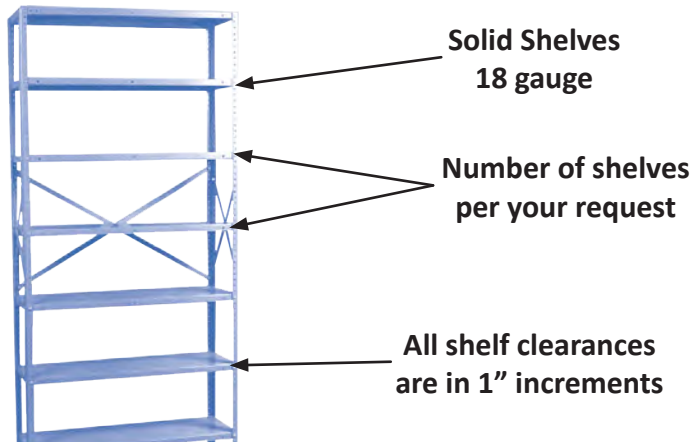

Class 1 (400 to 450 lbs)		Class 2 (700 to 1100 lbs)		Class 3 (1300 to 1800 lbs)	
Catalog#	Size Inches	Catalog#	Size Inches	Catalog#	Size Inches
14-1242-1	12 x 36 x 42	14-1242-2	12 x 36 x 42	Due to recent tariffs metal pricing must be verified with every order.	
14-1260-1	12 x 36 x 60	14-1260-2	12 x 36 x 60		
14-1272-1	12 x 36 x 72	14-1272-2	12 x 36 x 72		
14-1284-1	12 x 36 x 84	14-1284-2	12 x 36 x 84		
14-1296-1	12 x 36 x 96	14-1296-2	12 x 36 x 96		
14-1542-1	15 x 36 x 42	14-1542-2	15 x 36 x 42		
14-1560-1	15 x 36 x 60	14-1560-2	15 x 36 x 60		
14-1572-1	15 x 36 x 72	14-1572-2	15 x 36 x 72		
14-1584-1	15 x 36 x 84	14-1584-2	15 x 36 x 84		
14-1596-1	15 x 36 x 96	14-1596-2	15 x 36 x 96		
14-1842-1	18 x 36 x 42	14-1842-2	18 x 36 x 42	14-1842-3	18 x 36 x 42
14-1860-1	18 x 36 x 60	14-1860-2	18 x 36 x 60	14-1860-3	18 x 36 x 60
14-1872-1	18 x 36 x 72	14-1872-2	18 x 36 x 72	14-1872-3	18 x 36 x 72
14-1884-1	18 x 36 x 84	14-1884-2	18 x 36 x 84	14-1884-3	18 x 36 x 84
14-1896-1	18 x 36 x 96	14-1896-2	18 x 36 x 96	14-1896-3	18 x 36 x 96
14-2442-1	24 x 36 x 42	14-2442-2	24 x 36 x 42	14-2442-3	24 x 36 x 42
14-2460-1	24 x 36 x 60	14-2460-2	24 x 36 x 60	14-2460-3	24 x 36 x 60
14-2472-1	24 x 36 x 72	14-2472-2	24 x 36 x 72	14-2472-3	24 x 36 x 72
14-2484-1	24 x 36 x 84	14-2484-2	24 x 36 x 84	14-2484-3	24 x 36 x 84
14-2496-1	24 x 36 x 96	14-2496-2	24 x 36 x 96	14-2496-3	24 x 36 x 96
14-3042-1	30 x 36 x 42	14-3042-2	30 x 36 x 42	14-3042-3	30 x 36 x 42
14-3060-1	30 x 36 x 60	14-3060-2	30 x 36 x 60	14-3060-3	30 x 36 x 60
14-3072-1	30 x 36 x 72	14-3072-2	30 x 36 x 72	14-3072-3	30 x 36 x 72
14-3084-1	30 x 36 x 84	14-3084-2	30 x 36 x 84	14-3084-3	30 x 36 x 84
14-3096-1	30 x 36 x 96	14-3096-2	30 x 36 x 96	14-3096-3	30 x 36 x 96
14-3642-1	36 x 36 x 42	14-3642-2	36 x 36 x 42	14-3642-3	36 x 36 x 42
14-3660-1	36 x 36 x 60	14-3660-2	36 x 36 x 60	14-3660-3	36 x 36 x 60
14-3672-1	36 x 36 x 72	14-3672-2	36 x 36 x 72	14-3672-3	36 x 36 x 72
14-3684-1	36 x 36 x 84	14-3684-2	36 x 36 x 84	14-3684-3	36 x 36 x 84
14-C3696-1	36 x 36 x 96	14-3696-2	36 x 36 x 96	14-3696-3	36 x 36 x 96

CLOSED STEEL SHELVING UNITS

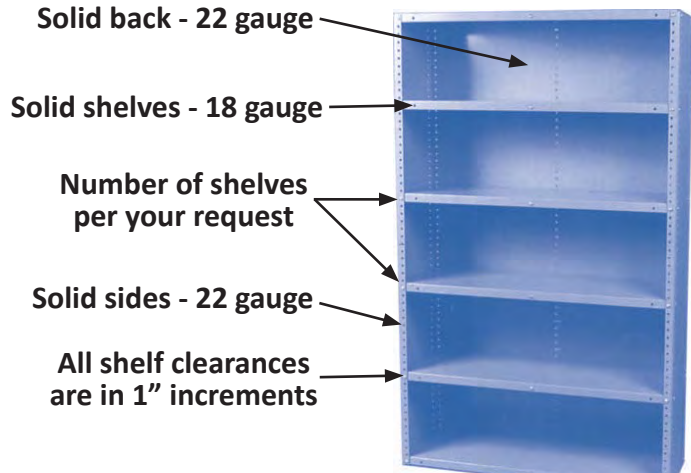

Class 1 (400 to 450 lbs)		Class 2 (700 to 1100 lbs)		Class 3 (1300 to 1800 lbs)	
Catalog#	Size Inches	Catalog#	Size Inches	Catalog#	Size Inches
14-C1242-1	12 x 36 x 42	14-C1242-2	12 x 36 x 42	<div style="border: 2px solid red; padding: 10px; text-align: center;"> <p>Due to recent tariffs metal pricing must be verified with every order.</p> </div>	
14-C1260-1	12 x 36 x 60	14-C1260-2	12 x 36 x 60		
14-C1272-1	12 x 36 x 72	14-C1272-2	12 x 36 x 72		
14-C1284-1	12 x 36 x 84	14-C1284-2	12 x 36 x 84		
14-C1296-1	12 x 36 x 96	14-C1296-2	12 x 36 x 96		
14-C1542-1	15 x 36 x 42	14-C1542-2	15 x 36 x 42		
14-C1560-1	15 x 36 x 60	14-C1560-2	15 x 36 x 60		
14-C1572-1	15 x 36 x 72	14-C1572-2	15 x 36 x 72		
14-C1584-1	15 x 36 x 84	14-C1584-2	15 x 36 x 84		
14-C1596-1	15 x 36 x 96	14-C1596-2	15 x 36 x 96		
14-C1842-1	18 x 36 x 42	14-C1842-2	18 x 36 x 42	14-C1842-3	18 x 36 x 42
14-C1860-1	18 x 36 x 60	14-C1860-2	18 x 36 x 60	14-C1860-3	18 x 36 x 60
14-C1872-1	18 x 36 x 72	14-C1872-2	18 x 36 x 72	14-C1872-3	18 x 36 x 72
14-C1884-1	18 x 36 x 84	14-C1884-2	18 x 36 x 84	14-C1884-3	18 x 36 x 84
14-C1896-1	18 x 36 x 96	14-C1896-2	18 x 36 x 96	14-C1896-3	18 x 36 x 96
14-C2442-1	24 x 36 x 42	14-C2442-2	24 x 36 x 42	14-C2442-3	24 x 36 x 42
14-C2460-1	24 x 36 x 60	14-C2460-2	24 x 36 x 60	14-C2460-3	24 x 36 x 60
14-C2472-1	24 x 36 x 72	14-C2472-2	24 x 36 x 72	14-C2472-3	24 x 36 x 72
14-C2484-1	24 x 36 x 84	14-C2484-2	24 x 36 x 84	14-C2484-3	24 x 36 x 84
14-C2496-1	24 x 36 x 96	14-C2496-2	24 x 36 x 96	14-C2496-3	24 x 36 x 96
14-C3042-1	30 x 36 x 42	14-C3042-2	30 x 36 x 42	14-C3042-3	30 x 36 x 42
14-C3060-1	30 x 36 x 60	14-C3060-2	30 x 36 x 60	14-C3060-3	30 x 36 x 60
14-C3072-1	30 x 36 x 72	14-C3072-2	30 x 36 x 72	14-C3072-3	30 x 36 x 72
14-C3084-1	30 x 36 x 84	14-C3084-2	30 x 36 x 84	14-C3084-3	30 x 36 x 84
14-C3096-1	30 x 36 x 96	14-C3096-2	30 x 36 x 96	14-C3096-3	30 x 36 x 96
14-C3642-1	36 x 36 x 42	14-C3642-2	36 x 36 x 42	14-C3642-3	36 x 36 x 42
14-C3660-1	36 x 36 x 60	14-C3660-2	36 x 36 x 60	14-C3660-3	36 x 36 x 60
14-C3672-1	36 x 36 x 72	14-C3672-2	36 x 36 x 72	14-C3672-3	36 x 36 x 72
14-C3684-1	36 x 36 x 84	14-C3684-2	36 x 36 x 84	14-C3684-3	36 x 36 x 84
14-C3696-1	36 x 36 x 96	14-C3696-2	36 x 36 x 96	14-C3696-3	36 x 36 x 96

INDIVIDUAL SHELVING & ACCESSORIES

Individual Shelves					
Class 1 (400 to 450 lbs.)		Class 2 (700 - 1100 lbs.)		Class 3 (1300 - 1800 lbs.)	
Catalog #	Size Inches	Catalog #	Size Inches	Catalog #	Size Inches
14-1200-1	12 x 36	14-1200-2	12 x 36		
14-1500-1	15 x 36	14-1500-2	15 x 36		
14-1800-1	18 x 36	14-1800-2	18 x 36	14-1800-3	18 x 36
14-2400-1	24 x 36	14-2400-2	24 x 36	14-2400-3	24 x 36
14-3000-1	30 x 36	14-3000-2	30 x 36	14-3000-3	30 x 36
14-3600-1	36 x 36	14-3600-2	36 x 36	14-3600-3	36 x 36

Shelving Sides					
Catalog #	Size Inches	Catalog #	Size Inches	Catalog #	Size Inches
14-S4212	12 x 42	14-S6012	12 x 60	14-S7212	12 x 72
14-S4215	15 x 42	14-S6015	15 x 60	14-S7215	15 x 72
14-S4218	18 x 42	14-S6018	18 x 60	14-S7218	18 x 72
14-S4224	24 x 42	14-S6024	24 x 60	14-S7224	24 x 72
14-S4230	30 x 42	14-S6030	30 x 60	14-S7230	30 x 72
14-S4236	36 x 42	14-S6036	36 x 60	14-S7236	36 x 72

Catalog #	Size Inches	Catalog #	Size Inches
14-S8412	12 x 84	14-S9612	12 x 96
14-S8415	15 x 84	14-S9615	15 x 96
14-S8418	18 x 84	14-S9618	18 x 96
14-S8424	24 x 84	14-S9624	24 x 96
14-S8430	30 x 84	14-S9630	30 x 96
14-S8436	36 x 84	14-S9636	36 x 96

Due to recent tariffs metal pricing must be verified with every order.

Shelving Backs		Corner Posts (units of 4)	
Catalog #	Size Inches	Catalog #	Size Inches
14-B3642	36 x 42	14-P42	42
14-B3660	36 x 60	14-P60	60
14-B3672	36 x 72	14-P72	72
14-B3684	36 x 84	14-P84	84
14-B3696	36 x 96	14-P96	96

Side Braces (units of 4)		Bin Dividers	
Catalog #	Size Inches	Catalog #	Size Inches
14-SB-12	12	14-0212	12 x 12
14-SB-15	15	14-0215	12 x 15
14-SB-18	18	14-0218	12 x 18
14-SB-24	24	14-0224	12 x 24
14-SB-30	30	14-0230	12 x 30
14-SB-36	36	14-0236	12 x 36

Bin Fronts		Back Braces (units of 2)	
Catalog #	Size Inches	Catalog #	Size Inches
14-0336	36	14-BB-36	36
		14-BB-48	48

GENERAL INFORMATION SHELVING

Shelving Classes 1 - 2 - 3

*width, depth and load capacities
(sway braces: 2 back 4 side)*

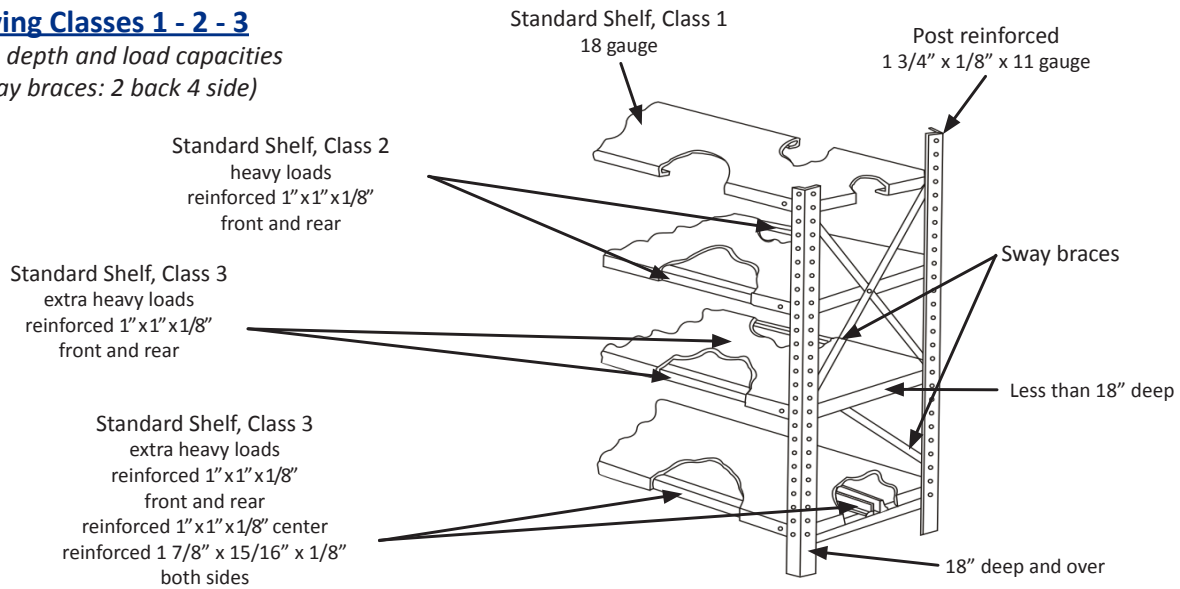

Shelf Sizes in inches		Pounds per Shelf		
Depth	Width	Class No. 1	Class No. 2	Class No. 3
12	36	400	1000	1500
15	36	400	1100	1650
18	36	450	1000	1800
24	36	450	1000	1700
30	36	450	860	1500
36	36	450	700	1300

Load capacity per shelf - Classes 1 - 2 - 3

Order by catalog product number only: It is only necessary to show the catalog product number and color choice on your order.

Send all orders to:

**Kentucky Correctional Industries
1041 Leestown Road
Frankfort, Kentucky 40601
Telephone: 502-573-1040**

Prices: (All prices are subject to change without notice.) We reserve the right to bill at prices in effect at time of shipment.

Specifications: (Subject to change without notice.) All items listed include necessary fittings for assembly unless otherwise noted.

Color: All products have a durable baked on enamel. There are thirty (30) colors to choose from, as shown on pages 66 & 67.

Steel Shelving: All shelving units are constructed of high quality materials in accordance with trade practices. The manufacturing is supervised by qualified, experienced personnel.

Shelves: Are 18 gauge; posts are 11 gauge; backs and sides are 22 gauge; back and side sway braces are 1/8" x 1" round edge flat stock; label holders are 22 gauge; reinforcing angles for shelves are 11 gauge.

Both open and closed type shelving sections are available in three (3) classes for load capacity:

Class No. 1 - light loads - 400 lbs. to 450 lbs.

Class No. 2 - heavy loads - 700 lbs. to 1100 lbs.

Class No. 3 - extra heavy loads - 1300 lbs. to 1800 lbs.

(This is the weight for each shelf - see chart above)

For other shelving requirements contact sales representative.

(Example: sides only; backs only; etc.)

All measurements are in inches.

All shelving is adjustable on 1" centers.

PAINT SWATCHES

THERE ARE 39 STANDARD COLORS TO CHOOSE FROM AND EACH PRODUCT WILL HAVE A DURABLE BAKED-ON ENAMEL FINISH. COLORS SHOWN ARE A CLOSE REPRESENTATION OF COLOR PRODUCT.



CAPITOL BLUE
#S0 527



KENTUCKY BLUE
#S0-512



TRAFFIC BLUE
#PCTA59116, RAL 5017



PURELY PURPLE
#PCSA69100



COMMODORE BLUE
#SW6524



ULTRAMARINE BLUE
#PCTA59104, RAL 5002



EMERALD GREEN
#PCTA49102, RAL 6001

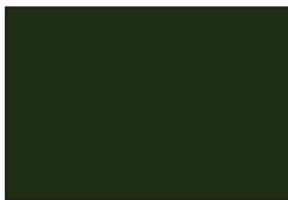

MOSS GREEN
#PCTA49106, RAL



FOREST GREEN
#PCT47100



HIGH GLOSS RED
#PCT60111



GLOSS REGAL RED
#PRS8 -C0008



CARMINE RED
#PCTT60158, RAL 3002



SIGNAL RED
#PCTA69102, RAL 3001



PURPLE RED
#PCTA69105, RAL 3004

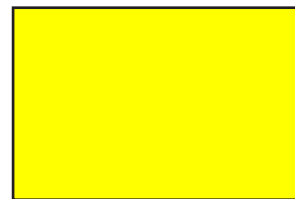

ZINC YELLOW
#PCTA39110, RAL 1018

PAINT SWATCHES

THERE ARE 39 STANDARD COLORS TO CHOOSE FROM AND EACH PRODUCT WILL HAVE A DURABLE BAKED-ON ENAMEL FINISH. COLORS SHOWN ARE A CLOSE REPRESENTATION OF COLOR PRODUCT.



CHOCOLATE BROWN
#PCTA29125



GREY BEIGE
#PCTA29105



GREY PRIMER
#PCM70140



TELEGREY2
#PCTA79126



AGATE GREY
#PCTA79120



XTREME CHROME
#PCTT75100



HAMMERSTONE BLACK
#PCTT90154



FLAT BLACK
#PCM90144



JET BLACK
#PCTA99104, RAL 9005



DULL BLACK
#PCT90236



CLEAR
#PCTT10101



SIGNAL WHITE
#PCTA89104, RAL 9003



OYSTER WHITE
#PCTA89102, RAL 1013



HIGH GLOSS WHITE
#PCT80211



CLEAR VISIO
#12784-01425

TEXTILES, MATTRESSES & PILLOWS



• **PRICES SUBJECT TO CHANGE WITHOUT NOTICE** •

TEXTILES

Uniforms & Scrubs

The following is a list of the catalog number prefixes that, when ordered, need to be followed by a size and choice of color. For example, when ordering a long-sleeved button-up shirt with collar (polyester blend) in a size 32, Khaki, express the catalog number as: 04-200-32-KH. Similarly, scrub pants in extra large, khaki would be: 04-775-XL-KH. For products, colors or sizes not shown here, (up to 10X possible); please contact your sales representative.



UNIFORMS - POLYESTER BLEND		SIZES		
		14-20	22-28	30-34
04-200-	Shirt, poly blend, L/S button-up, collar (specify size [14-34], color)	\$14	\$16	\$17
04-201-	Shirt, poly blend, S/S button-up, collar (specify size [14-34], color)	\$13	\$15	\$16
		26-44	46-50	52-60
04-600-	Pants, poly blend, with zipper, belt loops (specify size [26-60], color)	\$14	\$19	\$21



SCRUBS - POLYESTER BLEND		SIZES		
		S-XL	2XL-3XL	4XL-5XL
04-700-	Scrub Top, L/S poly blend, (specify size [S-5XL], color)	\$11	\$13	\$16
04-701-	Scrub Top, S/S poly blend, (specify size [S-5XL], color)	\$11	\$14	\$16
04-710-	Scrub Pants, poly blend, (specify size [S-5XL], color)	\$11	\$14	\$15
04-750-	Scrub Shorts, poly blend, no pockets, (specify size [S-5XL], color)	\$9	\$10	\$10
04-755-	Scrub Shorts, poly blend, with pockets, (specify size [S-5XL], color)	\$9	\$11	\$11

LEGEND/COLORS - UNIFORMS & SCRUBS

L/S - Long Sleeved	OR - Orange
S/S - Short Sleeved	KH - Khaki

TEXTILES

Uniforms & Scrubs



JACKETS - POLYESTER BLEND		SIZES	
		S-2XL	3XL-5XL
04-800-	Jacket, Long (specify size [S-5XL], color)	\$37	\$39
04-801-	Jacket, Short (specify size [S-5XL], color)	\$37	\$38



VESTS		PRICE
04-850-	Vest, safety (orange) - MESH/open front (specify size [S-4XL])	\$7
04-851-	Vest, safety (orange) - MESH/pull over(specify size [S-4XL])	\$8
04-855-	Vest, poly blend open front, Velcro fastened with side ties (specify size [S-4XL], color)	\$7
04-856-	Vest, poly blend pull-over, with side ties (specify size [S-4XL], color)	\$7
04-860-	Vest, poly blend with ID holder (specify size [S-4XL], color)	\$7

APRONS		PRICE
04-900	Apron, bib with pockets (specify color)	\$8
04-901	Apron, bib without pockets (specify color)	\$8

VEST / APRON COLORS
OR - Orange
KH - Khaki



TEXTILES

Transport Scrubs



TRANSPORT SCRUBS

AVAILABLE IN ORANGE ONLY		
04-TRANS-S-PANTS	Transport Scrub Pants, Poly Blend Small	\$12
04-TRANS-S-TOP	Transport Scrub Top, L/S, poly blend, belly chain pass through Small	\$13
04-TRANS-M-PANTS	Transport Scrub Pants, Poly Blend Medium	\$12
04-TRANS-M-TOPS	Transport Scrub Top, L/S, poly blend, belly chain pass through Medium	\$13
04-TRANS-L-PANTS	Transport Scrub Pants, Poly Blend Large	\$12
04-TRANS-L-TOP	Transport Scrub Top, L/S, poly blend, belly chain pass through Large	\$13
04-TRANS-XL-PANTS	Transport Scrub Pants, Poly Blend X-Large	\$12
04-TRANS-XL-TOP	Transport Scrub Top, L/S, poly blend, belly chain pass through X-Large	\$13
04-TRANS-2XL-PANTS	Transport Scrub Pants, Poly Blend 2XL	\$14
04-TRANS-2XL-TOP	Transport Scrub Top, L/S, poly blend, belly chain pass through 2XL	\$16
04-TRANS-3XL-PANTS	Transport Scrub Pants, Poly Blend 3XL	\$14
04-TRANS-3XL-TOP	Transport Scrub Top, L/S, poly blend, belly chain pass through 3XL	\$16
04-TRANS-4XL-PANTS	Transport Scrub Pants, Poly Blend 4XL	\$15
04-TRANS-4XL-TOP	Transport Scrub Top, L/S, poly blend, belly chain pass through 4XL	\$18
04-TRANS-5XL-PANTS	Transport Scrub Pants, Poly Blend 5XL	\$15
04-TRANS-5XL-TOP	Transport Scrub Top, L/S, poly blend, belly chain pass through 5XL	\$18
SCREEN PRINTING	KYDOC in Black ink, back of Scub Top	\$5

TEXTILES

T-shirts, Boxers, Socks & Belts



T-SHIRTS		SIZES					
		S-LG	XL	2XL	3XL	4XL	5XL
04-920	White T-Shirt (specify size [S-5X])	\$6	\$6	\$9	\$12	\$12	\$12
04-921	Orange T-Shirt (specify size [S-5X])	\$8		\$13			

POLYESTER BLEND



BOXERS		SIZES		
		28-38	40-44	46-48
04-925	White Only, (specify size [28-48])	\$5	\$5	\$6

SOCKS		PRICE
04-930	White Only, (one size only)	\$3



BELTS & BELT COMPONENTS		PRICE
04-935	Belt, Khaki (specify size - 28-60)	\$6
04-936	Buckle, replacement for belt	\$3
04-937	Tip, replacement for belt	\$2
04-938	Webbing for belt (50 yard roll)	\$75

TEXTILES

Bath & Bed



BATH		
Catalog #	Description	Price
04-940	Wash cloth, 12" x 12"	\$2
04-941	Hand towel, terry, 16" x 26" white only	\$4
04-942	Bath towel, terry, 20" x 40" white only	\$6
04-966	Laundry bag, mesh, 35" x 24"	\$7



BED		PRICE
Catalog #	Description	Price
04-950	Sheet, broadcloth, 99" x 55", white only	\$8
04-952	Pillow case, broadcloth, 27" x 20" white only	\$3
04-955	Blanket, wool, grey, 86" x 62"	\$27
04-957	Blanket, white, hospital style, 66" x 90"	\$21
04-958	Blanket, polyacrylic blend, grey with blue strip	\$21

MATTRESSES & PILLOWS

Mattresses & Pillows

INSTITUTIONAL / JAIL / PRISON MATTRESSES			
Catalog #	Description	Size	Price
13-CI-HS-2575-5	Heat Sealed, Fiber Core Mattress w/ Clearview Ticking	25"W x 75"L x 5"H	\$118
13-CI-HS-2580-5	Heat Sealed, Fiber Core Mattress w/ Clearview Ticking	25"W x 80"L x 5"H	\$132
13-CI-IPM-HS-2575-5	Heat Sealed, Fiber Core Integrated Pillow w/Clearview Ticking	25"W x 75"L x 5"H	\$123
13-CI-IPM-HS-2580-5	Heat Sealed, Fiber Core Integrated Pillow w/Clearview Ticking	25"W x 80"L x 5"H	\$137

CI - Heat Sealed, Fiber Core Mattress

Clearview Ticking, Anti-Microbial



IPM - Heat Sealed, Foam Core Integrated Pillow Mattress

Clearview Ticking, Anti-Microbial



PILLOWS			
Catalog #	DESCRIPTION	SIZE	PRICE
13-CBP-2026	Pillow with clearview ticking & batting fill	20"W x 26"L	\$22



SHOWER CURTAINS

PREA APPROVED



VELCRO LOOPS



GROMMETS

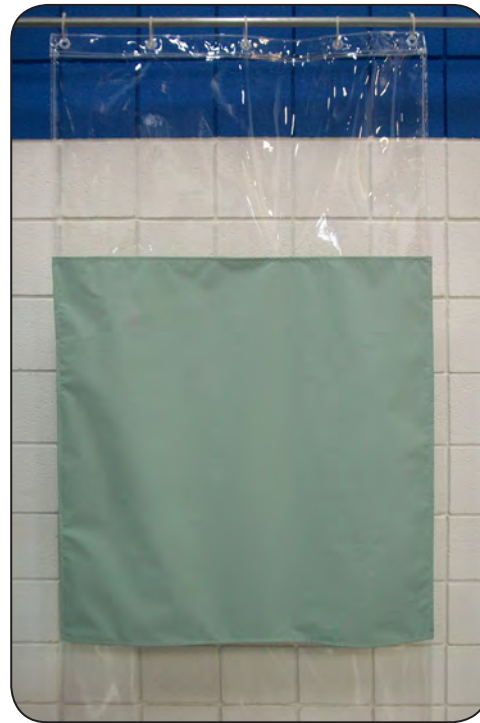

Catalog #	Description	Size	Price
13-PREA-CV-LOOP-SC	PREA approved shower curtain with velcro loops	36"W x 78"L	\$25
13-PREA-CV-GROM-SC	PREA approved shower curtain with grommets	36"W x 78"L	\$25

JANITORIAL SUPPLIES & CLEANING PRODUCTS

The **CorrectPac**[®] pre-measured, environmentally responsible cleaning system provides unique, easy-to-control products for custodial and food service operations linked with a complete, professional education program to teach proper use of materials.

The **CorrectPac**[®] system also provides the ability to monitor inventory and distribution, providing documentation, reducing cost and controlling the use of cleaning chemicals necessary for compliance in the accreditation process.



DepotPac[®]



Green Seal[™] Certified Products



Floor Care



Food Service



Red-Yellow-Green



Visit KCI's website @ kci.ky.gov
or call a KCI sales representative for more information.

• **PRICES SUBJECT TO CHANGE WITHOUT NOTICE** •

JANITORIAL

Jail Safe Broom

60" Large angle broom with Honeycomb Fiberglass handle & plastic fibers.

**Catalog #
23-2600**

Price: \$25

**Replacement
Handle** →



Jail Safe Broom Handle with Screw Tip

59" Honeycomb Fiberglass handle with threaded end.

**Catalog #
23-HTH56**

Price: \$20



Jail Safe Wooden Broom

58" Corn Bristle broom with no metal parts, wood handle.

**Catalog #
23-BCD30**

Price: \$25



Jail Safe Quick Change Mop Handle

63" jail safe quick change mop handle with Honeycomb Fiberglass and plastic handle. (used with loop end mop heads)

**Catalog #
23-HSW63**

Price: \$21



Jail Safe Jaws Mop Handle

63" jaw type mop handle with Honeycomb Fiberglass handle.

**Catalog #
23-HDCLP-JS**

Price: \$21



Jail Safe-Looped End Mop Head

LARGE

26 oz. Mop Head, tangle-free, Cotton Blend.

**Catalog # 23-MHTFHXL
Price: \$19**

REGULAR

16 oz. Mop Head, tangle-free, Cotton Blend.

**Catalog # 23-MHTFLM
Price: \$17**



Actual mop head may be different in appearance.

Cut End Mop Head

RAYON

16 oz. Mop Head
**Catalog # 23-MHNR24
Price: \$18**

COTTON

24 oz. Mop Head
1" Band Cotton 4 Ply
**Catalog #23-MHN24
Price: \$19**

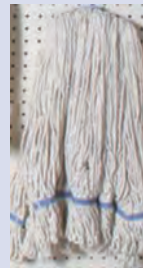

Actual mop head may be different in appearance.

JANITORIAL

9.5" Clip-On Dust Pan w/Rubber Blade for Fine Sweeping



Fits snugly onto 1" or 15/16" wide handles.

Catalog #
23-DPHD9.5
Price: \$11

also available is Jail Safe Dust Pan, all black and fiberglass handle, 37"width

Catalog # 23-DPHD-37
Price: \$25



Jail Safe Squeegee

22" plastic squeegee. Dual moss rubber blades & scrubbers.
(used with 23-HTH54)

Catalog # 23-JSDS
Price: \$23

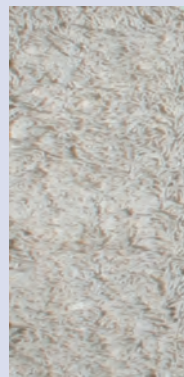

Jail Safe Dust Mop Head

36" x 5" dust mop head to be used with jail safe all plastic frame #23-DMFSQ36-5

Catalog # 23-DMHSQ36-5 \$21
Catalog # 23-DMHSQ18-5 \$17
Catalog # 23-DMHSQ24-5 \$19
Catalog # 23-DMHSQ48-5 \$24

Jail Safe Dust Mop Frame

36" x 5" jail safe all plastic frame.
(all sizes use with Catalog # 23-HTH54)

Catalog # 23-DMFSQ36-5
Price: \$29.00

also available is 18"x5", 24"x5" & 48"x5"

Catalog # 23-DMFSQ18-5 Price: \$27
Catalog # 23-DMFSQ24-5 Price: \$28
Catalog # 23-DMFSQ48-5 Price: \$32



Jail Safe Multipurpose Handle

56" Honeycomb Fiberglass jail safe cut end handle.
(used with all dust mop frames)



Catalog # 23-HTH54
Price: \$18

DETERGENTS

CATALOG #	GERMICIDAL	PRICE
23-CP201	Germicidal detergent disinfectant cleaner - 4 ctns, 528 pacs/case	\$270
23-CP201A	Germicidal detergent disinfectant cleaner - 2 ctns, 264 pacs/case	\$134
23-CP201B	Germicidal detergent disinfectant cleaner - 1 carton, 132 pacs	\$67
23-CP202	Germicidal detergent 2 disinfectant cleaner - 4 cartons, 528 pacs/case	\$269
23-CP202A	Germicidal detergent 2 disinfectant cleaner - 2 cartons, 264 pacs/case	\$134
23-CP202B	Germicidal detergent 2 disinfectant cleaner - 1 carton, 132 pacs	\$67
23-CP204	Germicidal detergent 4 disinfectant cleaner - 4 cartons, 160 pacs/case	\$218
23-CP204A	Germicidal detergent 4 disinfectant cleaner - 2 cartons, 80 pacs/case	\$109
23-CP204B	Germicidal detergent 4 disinfectant cleaner - 1 carton, 40 pacs	\$55
23-CP205	DepotPac germicidal detergent-refill system - 6 cartons, 120 pacs/case	\$267
23-CP205A	DepotPac germicidal detergent-refill system - 3 cartons, 60 pacs/case	\$133
23-CP205B	DepotPac germicidal detergent-refill system - 2 cartons, 40 pacs/case	\$57
23-CP232	Germicidal detergent disinfectant cleaner- 4 cartons, 528 pacs/case	\$303
23-CP232A	Germicidal detergent disinfectant cleaner - 2 cartons, 264 pacs/case	\$151
23-CP232B	Germicidal detergent disinfectant cleaner - 1 carton, 132 pacs	\$76
23-CP264	Germicidal detergent disinfectant cleaner - 4 cartons, 96 pacs/case	\$243
23-CP264A	Germicidal detergent disinfectant cleaner - 2 cartons, 48 pacs/case	\$122
23-CP264B	Germicidal detergent disinfectant cleaner - 1 carton, 24 pacs	\$61

CATALOG #	BACTERIAL ENHANCED CLEANER	PRICE
23-CP2202	Bacterial enhancer cleaner detergent - 4 cartons, 240 pacs/case	\$546
23-CP2202A	Bacterial enhancer cleaner detergent - 2 cartons, 120 pacs/case	\$273
23-CP2202B	Bacterial enhancer cleaner detergent - 1 carton, 60 pacs	\$122

CATALOG #	AIR FRESHENER	PRICE
23-CP1705	DepotPac air freshener detergent refill system - 6 cartons, 36 pacs/case	\$418
23-CP1705A	DepotPac air freshener detergent refill system - 3 cartons, 18 pacs/case	\$205
23-CP1705B	DepotPac air freshener detergent refill system - 2 cartons, 12 pac/case	\$105
23-CP1732	Air freshener odor counteractant - 4 cartons, 480 pacs/case	\$420
23-CP1732A	Air freshener odor counteractant - 2 cartons, 240 pacs/case	\$210
23-CP1732B	Air freshener odor counteractant - 1 carton, 120 pacs	\$105

CATALOG #	CARPET & UPHOLSTERY	PRICE
23-PP1203	SteamPac - 3 - carpet extraction detergent - 4 cartons, 288 pacs/case	\$310
23-PP1203A	SteamPac - 3 - carpet extraction detergent - 2 cartons, 144 pacs/case	\$154
23-PP1203B	SteamPac - 3 - carpet extraction detergent - 1 carton, 72 pacs	\$78
23-PP1207	SteamPac - 7 - carpet extraction detergent - 4 cartons, 144 pacs/case	\$289
23-PP1207A	SteamPac - 7 - carpet extraction detergent - 2 cartons, 72 pacs/case	\$144
23-PP1207B	SteamPac - 7 - carpet extraction detergent - 1 carton, 36 pacs	\$72
23-PP1210	SteamPac - 10 - carpet extraction detergent - 4 cartons, 120 pacs/case	\$314
23-PP1210A	SteamPac - 10 - carpet extraction detergent - 2 cartons, 60 pacs/case	\$158
23-PP1210B	SteamPac - 10 - carpet extraction detergent - 1 carton, 30 pacs	\$79

DETERGENTS

CATALOG #	ALL PURPOSE	PRICE
23-CP102	ScrubPac 2 - Heavy duty all purpose detergent - 4 cartons, 528 pacs/case	\$485
23-CP102A	ScrubPac 2 - Heavy duty all purpose detergent - 2 cartons, 264 pacs/case	\$243
23-CP102B	ScrubPac 2 - Heavy duty all purpose detergent - 1 carton, 132 pacs	\$122
23-CP104	ScrubPac 4 - Heavy duty all purpose detergent - 4 cartons, 288 pacs/case	\$461
23-CP104A	ScrubPac 4 - Heavy duty all purpose detergent - 2 cartons, 144 pacs/case	\$230
23-CP104B	ScrubPac 4 - Heavy duty all purpose detergent - 1 carton, 72 pacs	\$116
23-CP105	DepotPac Cleaner/Heavy duty all purpose detergent - 6 cartons, 36 pacs/case	\$364
23-CP105A	DepotPac Cleaner/Heavy duty all purpose detergent - 3 cartons, 18 pacs/case	\$182
23-CP105B	DepotPac Cleaner/Heavy duty all purpose detergent - 2 cartons, 12 pacs/case	\$91

CATALOG #	DEGREASER	PRICE
23-CP304	Degreaser - 4 cartons, 120 pacs/case	\$424
23-CP304A	Degreaser - 2 cartons, 60 pacs/case	\$212
23-CP304B	Degreaser - 1 carton, 30 pacs	\$106
23-CP314	Mi StripPac Floor finish remover - 4 cartons, 104 pacs/case	\$455
23-CP314A	Mi StripPac Floor finish remover - 2 cartons, 52 pacs/case	\$228
23-CP314B	Mi StripPac Floor finish remover - 1 carton, 26 pacs	\$113

CATALOG #	POT & PAN	PRICE
23-CP1525	Heavy duty pot and pan detergent - 4 cartons, 160 pacs/case	\$364
23-CP1525A	Heavy duty pot and pan detergent - 2 cartons, 80 pacs/ case	\$182
23-CP1525B	Heavy duty pot and pan detergent - 1 carton, 40 pacs	\$91

CATALOG #	LAUNDRY & SHOWER	PRICE
23-5030	Laundry soap detergent lemon fragrance janitorial, Signal 15	\$76
23-5031	Laundry detergent with bleach soap janitorial, Formula 5	\$63
23-CP940HE	High efficiency laundry detergent - 432 pac/case - 4 cartons, 108 pacs ea.	\$314
23-5025	Safety Bleach, Dry, All fabric	\$76t



FLOOR CARE

CATALOG #	NEUTRAL CLEANER	PRICE
23-CP1802	Moppac lite - 2 neutral floor cleaner - 4 cartons, 720 pacs/case	\$443
23-CP1802A	Moppac lite - 2 neutral floor cleaner - 2 cartons, 360 pacs/case	\$222
23-CP1802B	Moppac lite - 2 neutral floor cleaner - 1 carton, 180 pacs	\$110
23-CP1804	Moppac lite - 2 neutral floor cleaner - 4 cartons, 432 pacs/case	\$400
23-CP1804A	Moppac lite - 2 neutral floor cleaner - 2 cartons, 216 pacs/case	\$201
23-CP1804B	Moppac lite - 2 neutral floor cleaner - 1 carton, 108 pacs	\$100
23-CP1805	CorrectPac DepotPac pH neutral floor cleaner 6 cartons, to the full case	\$424
23-CP1805A	CorrectPac DepotPac pH neutral floor cleaner 3 cartons, to the ½ case	\$212
23-CP1805B	CorrectPac DepotPac pH neutral floor cleaner 2 cartons, to the 1/3 case	\$106

CATALOG #	CONDITIONER	PRICE
23-CP404	Neutralpac-4 - floor conditioner neutralizer - 4 cartons, 432 pacs/case	\$352
23-CP404A	Neutralpac-4 - floor conditioner neutralizer - 2 cartons, 216 pacs/case	\$175
23-CP404B	Neutralpac-4 - floor conditioner neutralizer - 1 carton, 108 pacs	\$88

CATALOG #	RESTORE & WAX	PRICE
23-CP2102	Restore pac -2 floor finish restorer - 4 cartons, 24 pacs/case	\$389
23-CP2102A	Restore pac -2 floor finish restorer - 2 cartons, 12 pacs/case	\$194
23-CP2102B	Restore pac -2 floor finish restorer - 1 carton, 6 pacs	\$97
23-CP2464	High gloss floor finish wax - 4 cartons, 12 pacs/case	\$170
23-CP2464A	High gloss floor finish wax - 2 cartons, 6 pacs/case	\$85
23-CP2464B	High gloss floor finish wax - 1 carton, 3 pacs	\$43

CATALOG #	BUFFING	PRICE
23-CP2132	Acrylic floor finish spray buff - 4 cartons, 160 pacs/case	\$364
23-CP2132A	Acrylic floor finish spray buff - 2 cartons, 80 pacs/case	\$182
23-CP2132B	Acrylic floor finish spray buff - 1 carton, 40 pacs	\$91



CLEANERS

CATALOG #	TOILET BOWL & SHOWER CLEANERS	PRICE
23-CP505	Depotpac toilet clean detergent refill system - 6 cartons, 18 pacs/case	\$328
23-CP505A	Depotpac toilet bowl cleaner - 3 cartons, 9 pacs/case	\$164
23-CP505B	Depotpac toilet bowl cleaner - 2 cartons, 6 pacs/case	\$84
23-CP532	Toilet bowl cleaner - 4 cartons, 312 pacs/case	\$364
23-CP532A	Toilet bowl cleaner - 2 cartons, 156 pacs/case	\$183
23-CP532B	Toilet bowl cleaner - 1 carton, 78 pacs	\$91

CATALOG #	SANITIZER	PRICE
23-CP1617	Sanitizer - 4 cartons, 128 pacs/case	\$255
23-CP1617A	Sanitizer - 2 cartons, 64 pacs/case	\$127
23-CP1617B	Sanitizer - 1 carton, 32 pacs	\$64
23-HDSAN	Alcohol free, hand sanitizer - refill cartridges	\$113
23-CPAS000166	Sanitizer test strips	\$72
23-CPMT151	MyTerra Hand-Care, Hand Sanitizer Foam – 8 pouches per case, sold by full case **This item will work in the 23-CPMT001 Hand-Care Program Dispenser**	\$116

CATALOG #	GLASS CLEANERS	PRICE
23-CP1405	Depot glass cleaner - 6 cartons, 36 pacs/case	\$316
23-CP1405A	Depot glass cleaner - 3 cartons, 18 pacs/case	\$159
23-CP1405B	Depot glass cleaner - 2 cartons, 12 pacs/case	\$79
23-CP1432	Glass cleaner - 4 cartons, 132 pacs per ctn/528 per case	\$376
23-CP1432A	One half case glass cleaner - 2 cartons, 132 pacs per ctn/264 pacs per ½ case	\$188
23-CP1432B	One fourth case glass cleaner - 1 carton, 132 pacs per ctn/¼ case	\$95

CATALOG #	SOAP	PRICE
23-CPMT101	MyTerra Hand Wash Foam, 8 – 1000ml pouches per case, sold by full cases	\$88



MISCELLANEOUS

CATALOG #	BOTTLES, DISPENSERS, SPIGOTS & SPRAYERS	PRICE
23-3203CAP	Spout cap for 32 oz. bottles, sold individually	\$3
23-CP1602	16 oz. bottle with sprayer, Germicide detergent	\$4
23-CP3201	32 oz. bottle with sprayer, Heavy duty all purpose bottle	\$4
23-CP3202	32 oz. bottle with sprayer, Germicide detergent	\$4
23-CP3203	32 oz. bottle and sprayer, Degreaser orange	\$4
23-CP3205	32 oz. bottle with spout cap, Bathroom cleaner	\$4
23-CP3214	32 oz. bottle with sprayer, Glass cleaner	\$4
23-CP3215	32 oz. bottle with spout cap, Pot and pan	\$4
23-CP3216	32 oz. Sanitizer bottle with sprayer	\$4
23-CP3217	32 oz. Air freshener bottle with sprayer	\$4
23-CP3221	32 oz. Spray buff bottle with sprayer	\$4
23-CP3222	32 oz. Bacpac bottle with sprayer	\$4
23-CP50640	5 Gallon depot system dispenser janitorial	\$20
23-CP50650	Spigot for 5 gallon depot system dispenser	\$5
23-CP6402	Sanitizer stock solution bottle germicidal with pump, half gallon	\$8
23-CP6416	Half gallon sanitizer stock solution bottle with pump grey	\$8
23-CP60000	White sprayer for 32 oz. quart bottle janitorial	\$4
23-CPMT001	MyTerra Hand-Care program Dispenser, sold individually	\$8
23-HDSAN DISP	Dispenser for 23-HDSAN products	\$16



MISCELLANEOUS

CATALOG #	MOPS, BROOMS, DUST PANS, MISCELLANEOUS	PRICE
23-BCD30	(Jail-safe) 61" warehouse cornbroom with no metal parts, wood handle	\$25
23-2600	(Jail safe) 57" large angle broom w/honeycomb fiberglass handle & nylon thread	\$25
23-PB24	(Jail safe) correctional safe 24" push broom, black plastic block, polypropylene fibers with threaded tip	\$23
23-BRTBPH	(Jail safe) toilet bowl brush - 17" plastic nylon handle (unbreakable)	\$11
23-DMFSQ18-5	(Jail safe) 18" x 5" dust mop frame, all plastic (use with 2041 jail)	\$27
23-DMFSQ24-5	(Jail safe) 24" x 5" dust mop frame, all plastic (use with 2041 jail)	\$28
23-DMFSQ36-5	(Jail safe) 36" x 5" dust mop frame, all plastic (use with 2041 jail)	\$31
23-DMFSQ48-5	(Jail safe) 48" x 5" dust mop frame, all plastic (use with 2041 jail)	\$33
23-DMHSQ18-5	Dust mop head 18" x 5"	\$17
23-DMH24-5	Dust mop head 24" x 5"	\$19
23-DMHSQ36-5	Dust mop head 36" x 5"	\$21
23-DMHSQ48-5	Dust mop head 48" x 5"	\$24
23-DMFTS	Mitt dust cotton mop frame triangle shape	\$15
23-DMHC	Mitt dust cotton mop head 4 1/2" x 10"	\$20
23-DPHD-9.5	Dust pan heavy duty 9 1/2" wide	\$12
23-DPHD-37	Dust pan heavy duty - 37" dust pan lobby-pro 37"	\$25
23-HDCLP-JS	(Jail safe) 63" jaw-type dust mop handle w/honeycomb fiberglass handle	\$21
23-HSW63	(Jail safe) 63" quick-change mop handle honeycomb fiberglass handle	\$21
23-HTH54	(Jail safe) 56" honeycomb fiberglass handle w/cut end	\$18
23-HTH56	(Jail safe) 59" honeycomb fiberglass handle, threaded tip	\$20
23-MHN24	Cut end cotton natural .60/4 Ply 32 oz. - With 1" band	\$19
23-MHTFLM	Mop head, tangle free, 16 oz. loop-end blended cotton	\$17
23-JSDS	Squeegee 22" plastic (jail safe) without handle, (use with 2041jail)	\$23
23-SB230310	Scrub brush, bi-level with stiff red plastic bristles	\$23
23-SBCON1121	Flat iron scrub brush with handle	\$11
23-CP43107	Pac cutter with tie	\$4
23-CP43114	Clip pac closer	\$16
23-CPAS00004	Bucket, white, unlabelled, sold individually	\$6
23-MHN32	Mophead, poly cotton, 32 oz. narrowband, cut end	\$21
23-ARMBLRJAIL	Mop bucket, jail safe, clear, 26 qt. w/mesh funnel wringer, 4 casters	\$191

CATALOG #	INFORMATIONAL POSTERS & LABELS	PRICE
23-CPL000087	DepotPac Floor Maintenance Poster	\$7
23-CPL000089	CorrectPac Floor Maintenance Poster	\$7
23-CPL000094	CorrectPac Food Service Cleaning System Poster	\$7
23- CPAT00019	Fill to this line sink Label, Wash	\$2
23- CPAT00020	Fill to this line sink Label, Rinse	\$2
23- CPAT00021	Fill to this line sink Label, Sanitizer	\$2



PRINT SERVICES

The KCI Print Shop has a wide variety of printing services and materials available. We print for individuals, businesses, athletic teams, and government agencies.

Our designers can help you create a custom product to meet your requirements. If you don't see what you need listed, please ask.

Offset & Digital Presses

- Business Cards
- Letterhead
- Envelopes
- Forms
- Certificates
- Labels
- Hang tags
- Newsletters
- Magazines
- Booklets
- Brochure
- Bookmarks
- Automobile novelty tags
- Posters (Limited Sizes)
- Yard Signs (Limited Sizes)

And more...

Transfer Printing (photos and other images)

- Team t-shirts
- Family reunions
- Company picnics
- Sweatshirts
- Bags
- Leather
- Hoodies
- Mugs

And more...



Fabric Printing

- Shirts
- T-shirts
- Sports apparel
- Polishing cloths
- Bags
- Hoodies
- Aprons

And more...

Embroidery

- Shirts
- Hats
- Backpacks
- Blankets
- Car seat covers
- Handkerchiefs
- Sports apparel
- Towels/cleaning cloths

And more...

Stickers

- Labeling
- Inventory bar codes
- Decorative

And more...



We do sequential numbering and mail-merge too.

Mark Croxton
mark.croxton@ky.gov

502.222.9058

Consider us for all your printing needs!

OFFSET AND DIGITAL PRESSES

Business Cards, Letterhead & Envelopes

Printing services are provided on a variety of papers with varied weight, textures, finishes and colors. For more durable media we can print on vinyl for stickers, labels, hang-tags and signs.

Business Cards - single or double sided, standard or custom size



Letterhead

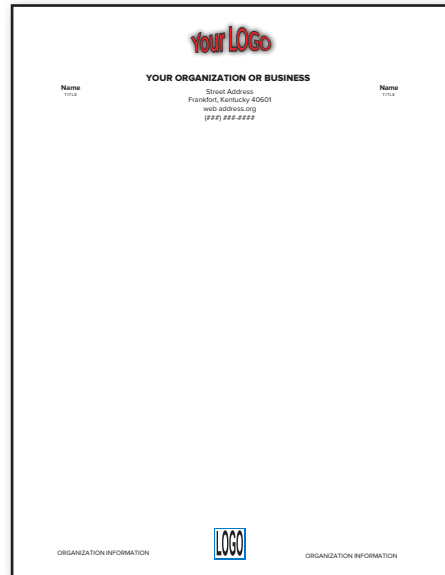
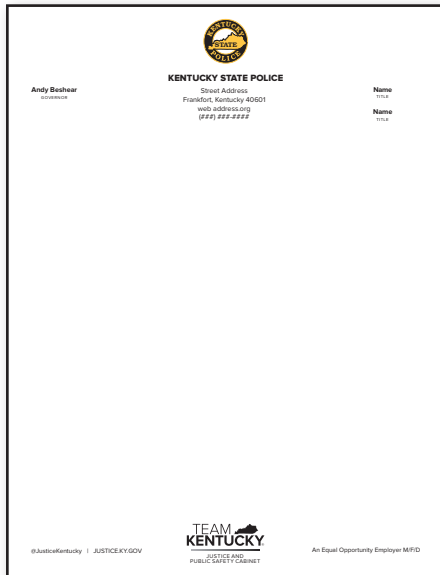

Envelopes - most standard sizes, with or without windows, may be pre-addressed using your database

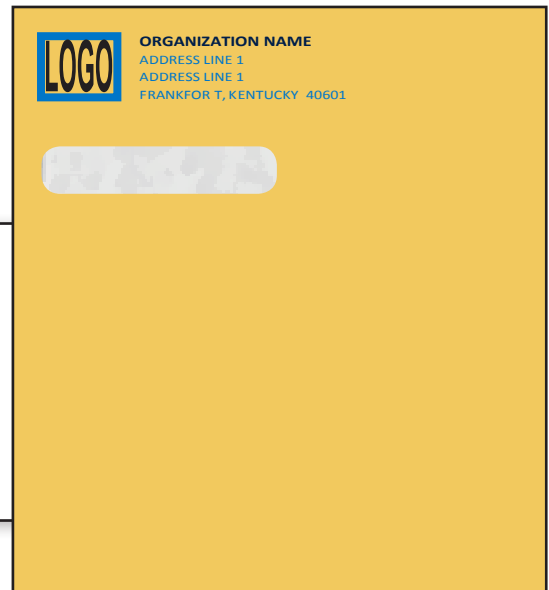
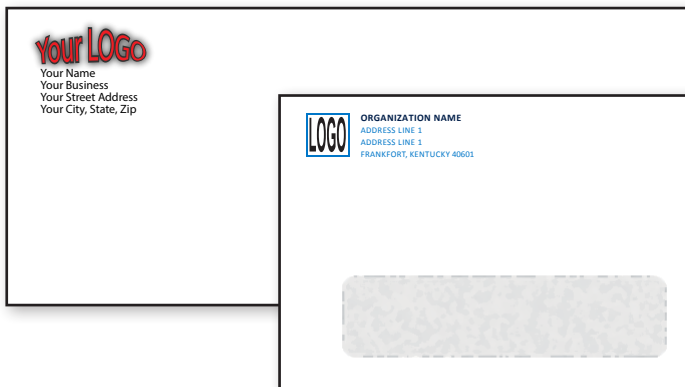

OFFSET AND DIGITAL PRESSES

Forms, Certificates & Hang Tags

Forms- single or multiple pages, multi section, sequentially numbered padded.



Padded forms with sequential numbering

Single page forms

Duplicate page forms

Certificates- blank, filled from database, sequentially numbered

Certificates with names from database

Certificates with names and numbers filled from database

Hang Tags



OFFSET AND DIGITAL PRESSES

Magazines, Booklets, Bookmarks, Calendars & Planners

Magazines, Booklets and Reports

Bookmarks

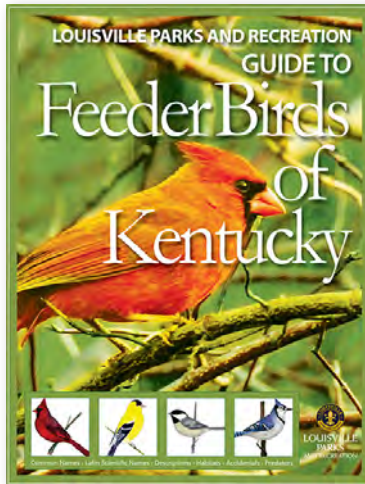

Calendars & Planners

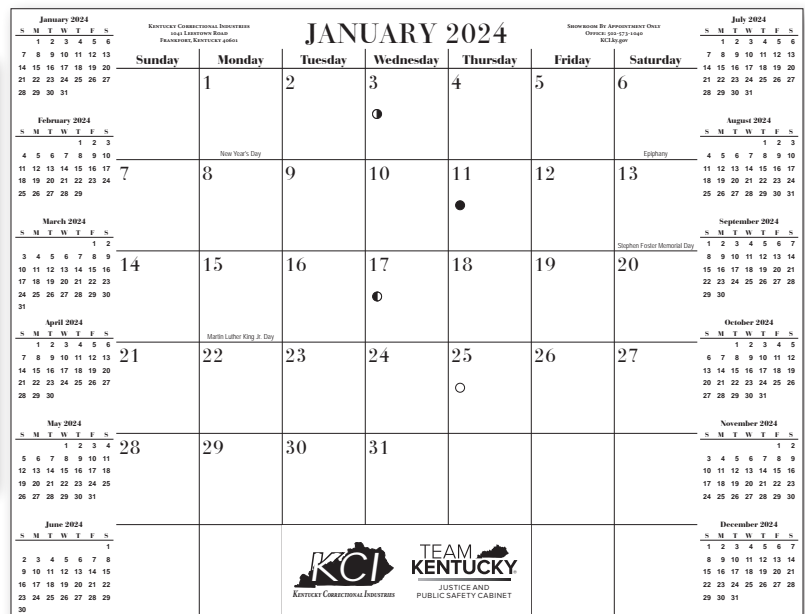

OFFSET AND DIGITAL PRESSES

Posters & Signs

Posters and Signs

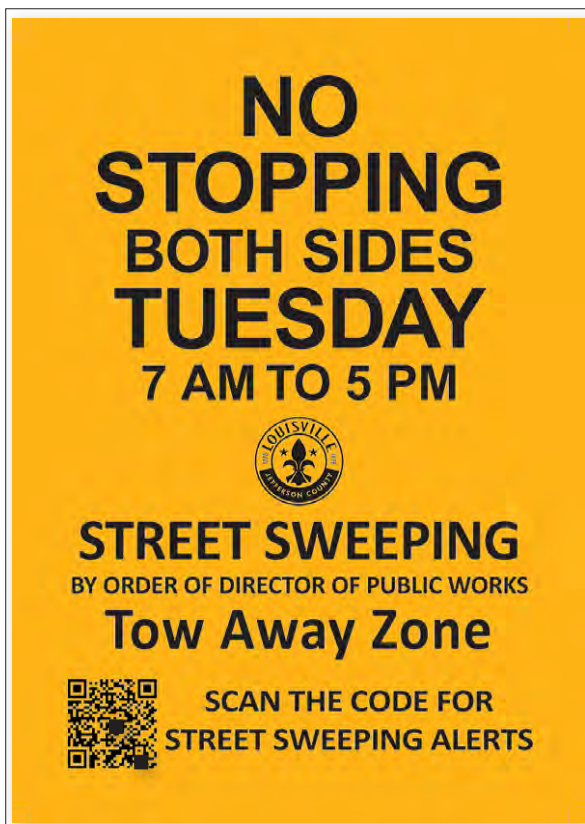
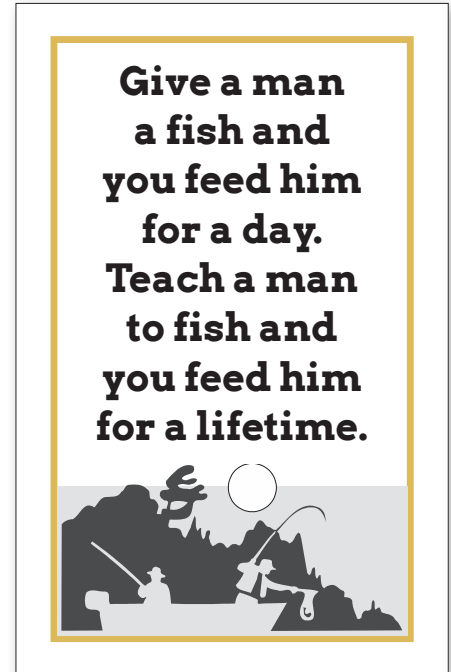

OFFSET AND DIGITAL PRESSES

Mail Merge, Sequential Numbering, Newsletters, Advertisements & Brochures

Mail Merge and Sequential Numbering

send your address database and we can create labels or address items to be mailed. Provide us with the desired range for sequential numbering and we will create the numbered documents you need.

Your LOGO
Your Name
Your Business
Your Street Address
Your City, State, Zip

Prsrtd
U.S. Postage
PAID
Elsewhere, KY
Permit #3

CUSTOMER NAME 1
ADDRESS 1
SOMETOWN KY 40000

Your LOGO
Your Name
Your Business
Your Street Address
Your City, State, Zip

Prsrtd
U.S. Postage
PAID
Elsewhere, KY
Permit #3

CUSTOMER NAME 2
ADDRESS 2
SOMETOWN KY 40000

Your LOGO
Your Name
Your Business
Your Street Address
Your City, State, Zip

Prsrtd
U.S. Postage
PAID
Elsewhere, KY
Permit #3

CUSTOMER NAME 3
ADDRESS 3
SOMETOWN KY 40000

AUCTION

NFO: 24-050001

NFO: 24-050002

NFO: 24-050003

Kentucky Housing, Buildings & Construction

Date _____ 20____

A rough-in inspection has been made and approved to be concealed.

CE # _____ ME # _____

NOT VALID FOR OCCUPANCY

Inspector # _____ Inspector Name _____

Location: _____

Newsletters, Ads & Brochures

WAY TO KNOW!

We noticed you're recycling right.
Keep up the great work!

¡Qué bueno que ya sabías!
Notamos que estás reciclando bien.



Download the free Recycle Coach app! Find your set out dates, guidelines, sign up for reminders, and more!
¡Encuentra sus fechas establecidas, pautas, regístrate para recibir recordatorios y más!

DEPARTMENT OF PUBLIC WORKS
WASTE MANAGEMENT DIVISION

KNOW
wastewise



Kentucky Public Health
Kentucky's Public Health Partner

KENTUCKY'S MEDICAL RESERVE CORPS (MRC)

In times of need, Kentucky helps.





ANYCALL RENOVATIONS
SPRING IS IN THE AIR
First 50 customers
Save 10%
Affordable prices - Quality work
Free estimates - Guaranteed satisfaction
Call today!

FREE! Coffee News
"Time to Get Forward
Over Coffee"
St. Matthews Edition
502-228-8210
Mailing 3/27 April 25, 2024

Everybody's Talking!
National Business Day is a national business day...
Every body...
Key Note: A national business day...
East walleye: A Chicago woman who lost her walleye fishing...
Quoteable Quotes
What's Happening
Prolift
Trivia

Care for Pets in Their Own Home
502-615-4665

I Help with Social Security Disability Applications and Appeals

SPARTAN SECURITY SOLUTIONS
502-228-8210

THIS SPACE FOR RENT
502-228-8210

Licensed Independent Agent providing Medicare Supplement Plans, Health Insurance on RYFLEX

INJURED?
CRAWL in Middletown
502-228-8210

On-site Furniture Repair
502-228-2280

TRANSFER PRINTING

Pendants, Ornaments, Mug, Tumblers and Textiles

With the transfer printing process we can place your image and text on a variety of materials: ceramic, metal, plastic, fabric and leather. We can accommodate orders for single or multiple orders. Great for family reunions, company picnics, celebrations, personalized & novelty items. We can provide blanks of a variety of products, just ask. Also good for team t-shirts, hoodies & sweatshirts.

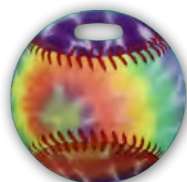

Pendant



Blank



Ornament



Blank



Mug



Blank



Lid with sliding valve in open position



Tumbler with lid



Let our designers work with you to create a design that can include text, a logo, team numbers, or other graphic elements.

EMBROIDERY

Our embroidery team can sew your image and text on a variety of fabric products. as. We can accommodate orders for single or multiple orders. Great for family reunions, company picnics, celebrations and personalized items. We can provide blanks of a variety of products, just ask.

JACKETS, T-SHIRTS, HOODIES, CAPS, SPORTS APPAREL,
BAGS, BACKPACKS, TOWELS, BLANKETS
AND MORE...



The embroidery designs can be sewn directly to garments
or some can be made as patches for you to apply



FABRIC PRINTING

"Silkscreen" or "Screen Printing"

The screen print team will work with you to create a design for you using your ideas or an existing design. These are applied to shirts, t-shirts, or other cloth products. These are great for large groups (churches, schools and businesses) or events (openings, field trips, sport tournaments, concerts, picnics, conventions).

JACKETS, T-SHIRTS, HOODIES, SPORTS APPAREL, BAGS,
HANDKERCHIEFS, CLEANING CLOTHS
AND MORE...



STICKERS & LABELS

The sticker team can design and print on paper & vinyl.

PACKAGE LABELS

INVENTORY, SPECIAL EVENT AND DECORATIVE STICKERS

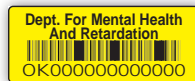

Consider the KCI Print Shop for all your printing needs.

CUSTOM PRODUCTS

- **METAL WORK**



- **REUPHOLSTERY**



- **WOOD FURNITURE, CRAFTS & ACCESSORIES**



• **PRICES SUBJECT TO CHANGE WITHOUT NOTICE** •

METAL PRODUCTS



**Due to recent tariffs
metal pricing
must be verified
with every order.**

REUPHOLSTERY



WOOD FURNITURE

Athletic Lockers with Customized School Logo

If you can imagine it, we can build it. Let KCI's Custom Woodworking plant make your dream a reality. If you have a space that is not quite conventional, give us a call and let our top notch sales and design staff help you every step of the way. We can custom build conference tables, bookcases, reception units, bunk beds, students desks, library carrels, wood shelving units, or whatever you can imagine. The following photos depict the range of custom items that can be designed and produced to meet your specific needs.

The following photos depict the range of custom items that can be designed and produced to meet your specific needs.



Athletic lockers with customized school logo

Contact your sales representative today with questions and for a price quote.

WOOD FURNITURE

Kitchen Island, Board Room, Conference Room & Treatment Table

*Below are examples of some quality work
KCI can provide for your everyday needs.*

IF YOU CAN IMAGINE IT, KCI CAN BUILD IT.



Kitchen Work Island on Casters



Board Room



Conference Room Storage



Medical/Treatment Table

Contact your sales representative today with questions and for a price quote.

WOOD FURNITURE

Mail or License Plate Cabinet, Magazine Rack, Bookcase, Reception Area



License Plate Cabinet



Magazine Rack



Bookcase



Reception Area

Contact your sales representative today with questions and for a price quote.

WOOD FURNITURE

Tables, Benches & Chairs



Tables, Benches and Chairs

Contact your sales representative today with questions and for a price quote.

CUSTOM WOOD FURNITURE

Podiums, Coat Trees & Business Card Holder

Examples of customization available at additional cost.

Free Standing Podiums



Table Top Podiums



Table Top Podium
front view



Table Top Podium
back view



Free standing podium
front view (cherry stain)
& back view (walnut stain)

Coat Trees



Coat Tree



Coat Tree with
umbrella stand

State Card Holder



CUSTOM HANDMADE ITEMS

Handmade Seals



3-D NATURAL WOOD



3-D NATURAL WOOD



LASER ENGRAVED



3-D WOOD & LASER



3-D PAINTED



HAND PAINTED

CALL FOR PRICING

CUSTOM HANDMADE ITEMS

Airbrushing, Nameplates & Billy Bats

CUSTOM AIRBRUSHING



CUSTOM NAMEPLATES & BILLY BATS



LASER ENGRAVED



BILLY BAT STAND
COASTER SETS
WOODEN CHALLENGE COINS
AVAILABLE UPON REQUEST

PERSONAL PROTECTIVE EQUIPMENT (PPE)

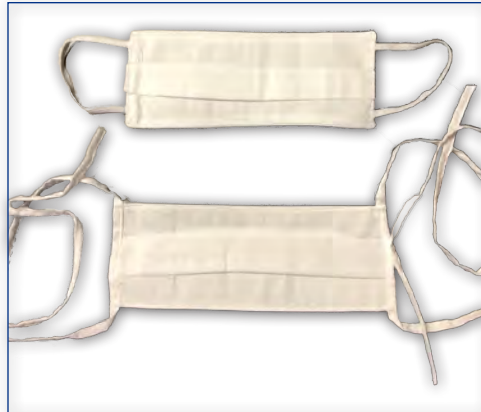

• **PRICES SUBJECT TO CHANGE WITHOUT NOTICE** •

OFFICE DESK BARRIER



**Custom Office Desk Barrier
Made for the Governor's Office**

PPE Plastic Barrier

Catalog #	Description	Size	Price
10-PPE BARRIER	Standard Office Desk Barrier	48x30	Call for quote

Contact your sales representative today with questions and for a price quote.

PPE SURGICAL MASKS

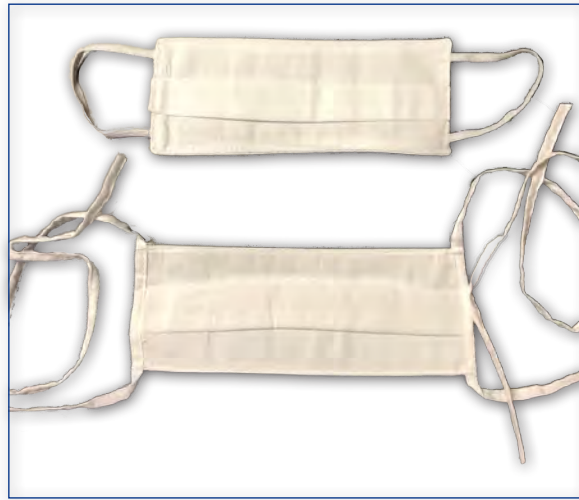

**Surgical Mask with Ties
(Latex Free)**



Surgical Mask with Elastic

PPE Surgical Masks

Catalog #	Description	Price
04-979	Surgical Mask w/ Ties (Latex Free)	\$2
04-980	Surgical Mask w/ Elastic	\$2

PPE MEDICAL POUCHES



**Medical Pouch
w/ elastic**



**Medical Pouch
w/ 1 way CPR Mask**

PPE Medical Pouches

Catalog #	Description	Price
04-971	Pouch, medical with elastic	\$10
04-971-CPR	Pouch, 1 way CPR Mask	\$12

PRISON INDUSTRY ENHANCEMENT CERTIFICATION PROGRAM (PIEPC)



We're **Kentucky Correctional Industries (KCI)** with seven statewide factories, over 60 years of proven history and a diverse range of production capabilities. We represent American manufacturing you can count on.

- Locations throughout Kentucky
- Kentucky Labor Force
- Kentucky Manufacturing and Services

Kentucky Correctional Industries is a program that truly “works” in every sense of the word, while providing the added benefit of changing lives.

**Let's Keep
Kentucky Working.
We're structured
for your success!**

PIECP

GET TO KNOW US!

What is PIECP?

- Also known as “PIE” the program operates under statutory authority of the U.S. Congress (18.U.S.C. § 1761 ©).
- Kentucky Correctional Industries is PIECP-certified which exempts it from the normal restrictions on the sale of inmate-made goods in interstate commerce.
- Program parameters are detailed within Kentucky Revised Statute 197.105.

Why Participate?

- The program provides a stable, readily available American workforce in low cost facilities to more competitively produce your products or provide your services.
- Through inmate pay deductions administrative orders for the support of dependents are fulfilled, crime victims are compensated and inmates’ families are supported.
- Inmates gain marketable skills in a realistic work setting which improves their prospects for employment upon release and a successful transition to contributing, tax paying members of society.

**PROVEN EXPERIENCE and
EXPERTISE COUNTS...
AND WE HAVE IT!**

GETTING STARTED...THE REQUIREMENTS

- Inmates will be paid (subject to allowable deductions) the prevailing wage for similar work performed in the locality and benefits comparable to private sector employees (overtime, workers compensation, etc.)
- Your company must certify in writing that the work performed
 - (1) will not displace employed private sector workers;
 - (2) will not be used in skills/trades where a surplus of available gainful labor in the locality; and
 - (3) will not significantly impair existing contracts.
- Prior to start-up KCI must notify organized labor and local private industry, comply with NEPA requirements and obtain written assurances from inmates that their participation is voluntary.
- The Bureau of Justice Assistance (BJA) grants approval for the project once a review of all documentation has been completed.

CURRENT WORK MANAGEMENT STRUCTURE

- **Employer Model:** The private sector partner owns and operates the project (hires, fires, trains, supervises and pays the inmate workforce). KCI assumes no major role in industry operations and exercises limited control over inmate labor performance.

PIECP FREQUENTLY ASKED QUESTIONS

Q: How is a fair inmate wage determined?

A: Demonstration that inmate workers are being paid in at least the 10th percentile of prevailing wages for similar work in that locale is generally required. Inmates cannot be paid below the standard federal minimum wage.

Q: Are inmates entitled to “employee benefits”?

A: Participation in the program is not to constitute an employee/employer relationship with the private sector partner leasing the inmate’s labor. Federal, State, and Local taxes, along with Social Security is deducted from the inmate’s pay, and worker’s compensation insurance is provided by the private sector partner, however no other “benefits” such as health or life insurance must be provided.

Q: Can our company personnel tour prospective sites?

A: Yes. KCI Personnel will arrange and accompany your designated representatives on a tour of any prospective facility.

Q: What about security of our staff working in a prison setting?

A: All state adult correctional facilities employ staff members from many different disciplines who work there every day. Staff who work in these facilities have a responsibility to follow security policies and procedures, which are in place to ensure their safety as well as the safety of the inmate population. Uniformed security staff, however, are employed in these facilities and are directly responsible for maintaining security and order.

Q: Can we utilize tools and chemicals necessary to complete our work?

A: Yes. All of our facilities have very detailed safety plans as well as tool and caustic control policies and procedures.

Q: Can we have deliveries, which would be made to a plant within a correctional facility?

A: Yes. All of our facilities have secure checkpoints/sally ports where deliveries can be made as needed, either by vehicle or on foot.

Q: Can we use tools and chemicals that are owned by the Department of Corrections (DOC) or KCI?

A: No. In the Employer model, the private sector partner would provide all necessary tools, etc.

Q: What about insurance?

A: KCI/DOC maintains insurance on all state owned property and equipment. The private sector partner would need to provide and maintain insurance on parts, tools, machinery, etc. that it owns and which is being used in a PIE operation. As well as providing workman's comp for inmates.

Q: What about shift work?

A: The inmate labor force would generally be available for standard day shift work Monday-Friday; however, in the event that occasional overtime is necessary, it may be approved by the DOC/KCI on an “as needed” basis.

Q: Can we alter, or renovate existing facilities that are owned by the DOC/KCI to meet our needs?

A: Yes. With the prior approval of the DOC/KCI.

Q: Can we hire inmates after they serve out or leave prison on parole?

A: Yes. The purpose behind PIE is to not only provide private sector partners with a skilled workforce, but to assist inmates by providing them with marketable skills and training which will make them viable candidates for careers after incarceration.

PRISON INDUSTRY ENHANCEMENT CERTIFICATION PROGRAM (PIECP)



We're **Kentucky Correctional Industries (KCI)** with seven statewide factories, over 60 years of proven history and a diverse range of production capabilities. We represent American manufacturing you can count on.

- Locations throughout Kentucky
- Kentucky Labor Force
- Kentucky Manufacturing and Services

Kentucky Correctional Industries is a program that truly “works” in every sense of the word, while providing the added benefit of changing lives.

**Let's Keep
Kentucky Working.
We're structured
for your success!**



TEAM KENTUCKY®

JUSTICE AND PUBLIC SAFETY CABINET

KENTUCKY CORRECTIONAL INDUSTRIES

**1041 LEESTOWN ROAD
FRANKFORT, KENTUCKY 40601**

**SHOWROOM: OPEN BY APPOINTMENT ONLY
OFFICE: 502-573-1040**

KCI.ky.gov

CATALOGS

Specifications in catalog are subject to change without notice. Descriptive, photographic or pricing errors are subject to correction.